

# FLUXWERX®

SPECIFICATION DATA

## NOTCH 2 AREA ASYMMETRIC (NT1-A)

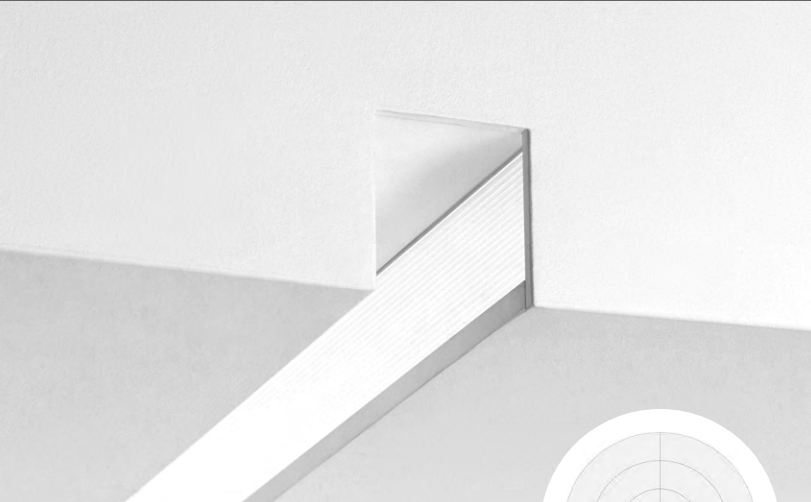

D2 – DRYWALL TRIMLESS SHOWN WITH (E) DADO ENDCAP OPTION

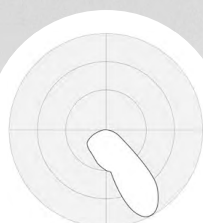

100% Dn Asymmetric

### CROSS SECTION

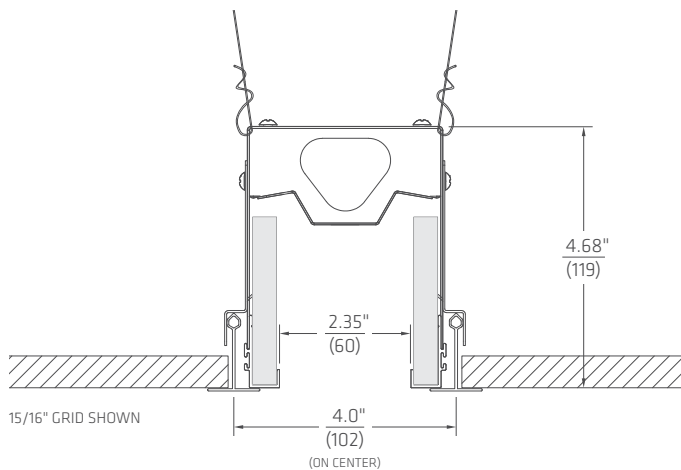

### CEILING & TRIM

DRYWALL TRIM



DRYWALL TRIMLESS



GRID



### CATALOG #

### PROJECT

### NOTES

### PERFORMANCE SUMMARY

	A	B
Light (lm/ft)	450	525
Energy (W/ft)	5	6
Efficacy (lm/W)	93	91
Color Rendering (CRI)	80+	
Color Accuracy (SDCM)	< 2	
Lumen Maintenance (hr)	L90 per TM-21: >60,000 L70 estimate: >200,000	

Summary values are nominal and based on 4000K CCT.

### FEATURES

- 2-1/3" open aperture design with fully luminous interior. No horizontal lenses or diffusers.
- Anidolic optics provide shielded, precisely controlled optical distributions, for low glare and wide row spacing.
- Up to 12 ft o.c. spacing, delivering 40 fc at less than 0.5 W/ft<sup>2</sup>.
- Length increments of 1' in drywall or 2' in T-grid ceilings.
- Dedicated 'L', 'T' and 'X' corners make it easy to create horizontal and vertical patterns.
- Optional Dado and Capsule drywall endcaps create a unique boundary for the line of light.
- 4" Armstrong TechZone® or 4" USG Logix® T-grid compatible.



SPECIFICATION DATA  
**NOTCH 2 AREA ASYMMETRIC (NT1-A)**

**ORDER GUIDE**

1	2	3	4	5	6	7	8	9	OPTIONS	CONTROLS
<b>NT1</b>			<b>A</b>							

1 FAMILY	2 VERSION	3 TRIM / CEILING	4 DISTRIBUTION	5 ENERGY <sup>2</sup>
<b>NT1</b> Notch 2 Area	<b>L</b> Linear Row <b>R</b> Pattern Side/Corner  <b>PATTERN<sup>1</sup></b> <b>P0</b> Square <b>P1</b> Rectangle <b>P2</b> 2-rows   1-corner <b>P3</b> 3-rows   2-corner <b>P4</b> 4-rows   3-corner <b>P5</b> 5-rows   4-corner  <small><sup>1</sup> Other pattern options available. See previous page or consult factory.</small>	<b>D1</b> Drywall – Trim Flange <b>D2</b> Drywall – Trimless <b>D3</b> Drywall – Drop Radius <b>D4</b> Drywall – Drop Square <b>G1</b> Grid – 9/16" or 15/16" Flat-T <b>G1</b> 9/16" Tegular or Bolt-Slot <b>G1</b> 4" Armstrong TechZone® or 4" USG Logix® <b>W2</b> Wall – Trimless	<b>A</b> Asymmetric	<b>A</b> 5 W/ft <b>B</b> 6 W/ft  <small><sup>2</sup> Add 1 W/ft for 347 V with E1-4/L1.</small>

6 CCT	7 DRIVER	8 VOLTAGE	9 LENGTH <sup>5</sup>
<b>30</b> 3000 K <b>35</b> 3500 K <b>40</b> 4000 K	<b>F1</b> Non-Dim <b>F2</b> 0-10 V Dim 3% <b>E1</b> eldoLED ECO 0-10 V Dim 1% <b>E2</b> eldoLED SOLO 0-10 V Dim 0.1% <b>E3</b> eldoLED ECO DALI Dim 1% <b>E4</b> eldoLED SOLO DALI Dim 0.1% <b>L1</b> Lutron Hi-Lume 1% EcoSystem (LDE1)	<b>M</b> 120-277 V <b>3</b> 347 V <sup>4</sup>  <small><sup>4</sup> 347 V Driver for F1. 347 V Transformer &amp; Driver for E1-4/L1.</small>	<b>XX</b> Drywall – Specify 1ft Increments <b>XX</b> Grid – Specify 2 ft Increments <b>LC</b> Corner (Flat 2 ft x 2 ft) <b>TN</b> T Intersection <sup>6</sup> <b>XN</b> X Intersection <sup>6</sup> <b>CW</b> Ceiling to Wall Transition <sup>7</sup>  <small><sup>5</sup> Minimum is 2 feet. <sup>6</sup> Available in D2 or W2 trim options. <sup>7</sup> Available in D2 trim option. Wall leg Light + Energy default is 'A'. Call factory for options.</small>

OPTIONS		CONTROLS	
WIRING & EMERGENCY	LAYOUT & FINISH	SENSORS & CONTROLLERS	
<b>A</b> Alternate Wiring (AV switching) <sup>8</sup> <b>B</b> Battery Pack <sup>9</sup> <b>F</b> 6' Flex Whip (in 1st module) <b>H</b> Emergency Switching (GTD or Controller) <b>M</b> EM or NL Wiring (2nd neutral) <sup>8</sup> <b>T</b> Throughwire Circuit <b>U</b> Throughwire (w/neutral)	<b>C</b> Chicago Plenum <b>E</b> Dado Endcap <sup>10</sup> <b>K</b> Black Trim and Endcap <b>P</b> Capsule Endcap <sup>11</sup>  <small><sup>10</sup> Available with D2 trim option. Default option is to install in one end only. Call factory for options. <sup>11</sup> Available in D2, D3 and W2 trim options.</small>	<b>RE1</b> Remote Enlighted Smart Sensor <b>VN1</b> Acuity nLight Converter	

**PRODUCT DETAILS**

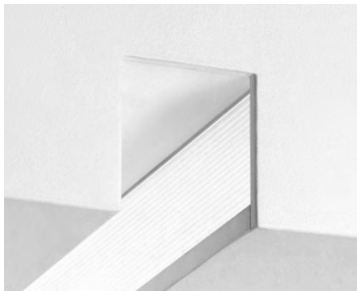

LINEAR ANIDOLIC OPTIC

**TRIM OPTIONS**

**TRIM**



D1 – DRYWALL TRIM FLANGE

**TRIMLESS**

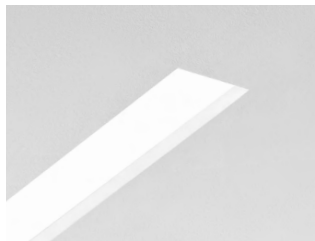

D2 – DRYWALL TRIMLESS

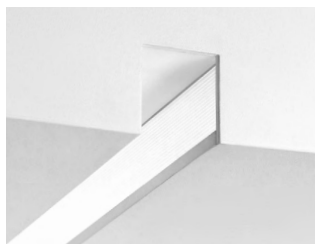

OPTIONAL – DADO ENDCAP



OPTIONAL – CAPSULE ENDCAP

**DROP TRIM**



D3 – DRYWALL DROP RADIUS



D4 – DRYWALL DROP SQUARE



OPTIONAL – CAPSULE ENDCAP

**GRID**



G1 – 9/16" GRID FLAT T



G1 – 15/16" GRID FLAT T

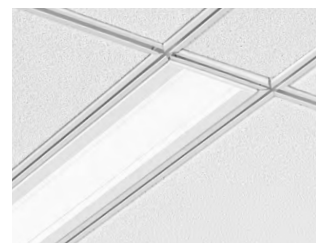

G1 – 9/16" TEGULAR | SLOT GRID

NOTE: Use G1 for 4" Armstrong TechZone® or 4" USG Logix®

**DIMENSIONS**

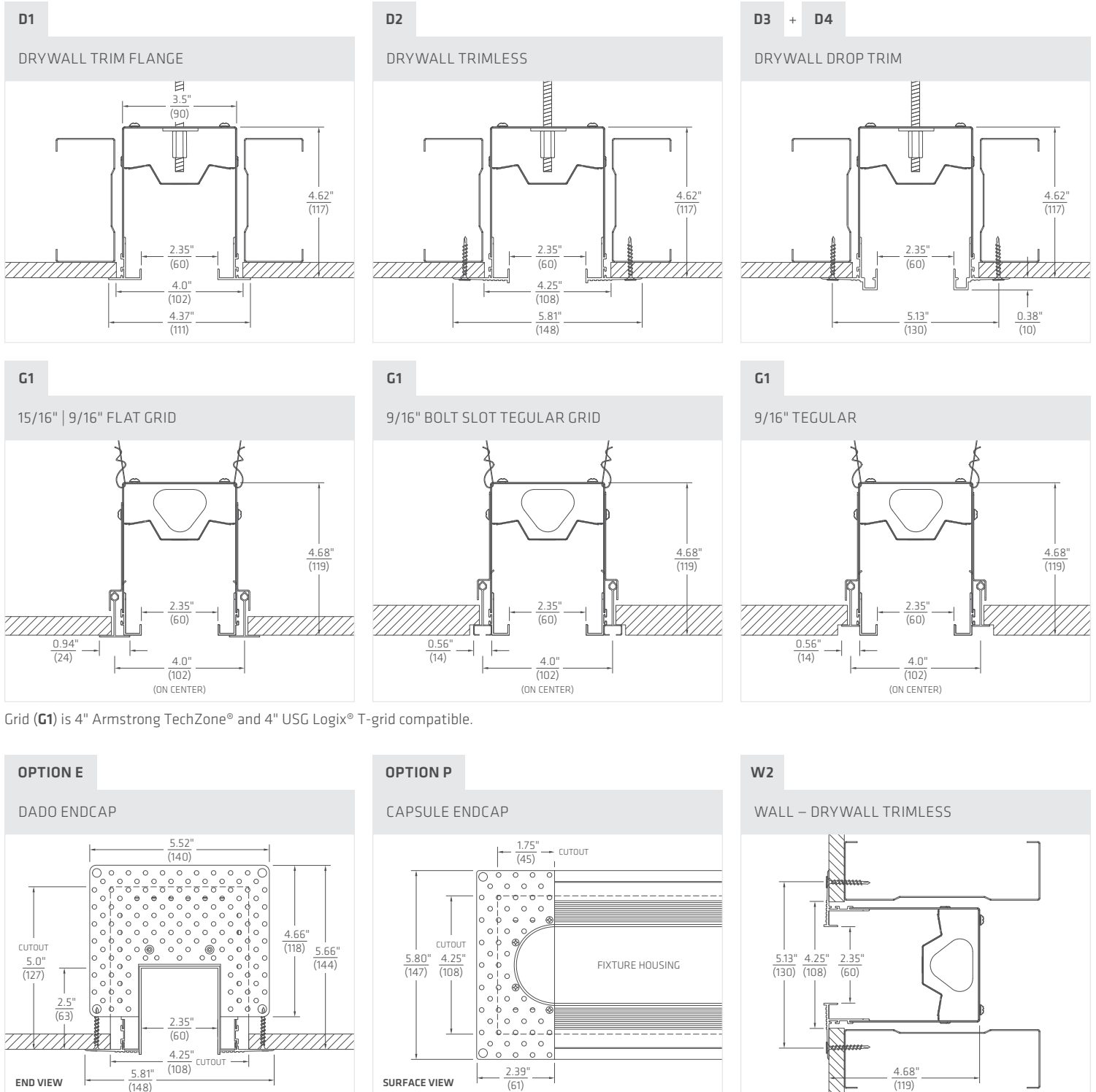

Grid (G1) is 4" Armstrong TechZone® and 4" USG Logix® T-grid compatible.

**LINEAR ROWS & FIXTURES**

Continuous rows are available in nominal 1' increments in drywall ceilings and in 2' increments on-grid for T-bar ceilings. Standalone fixtures are available in 2', 3', 4', or 8' sizes.



NOTE: Run lengths are nominal and vary with ceiling condition and trim selections.

**DRYWALL CUTOUT DIMENSIONS**

To determine the overall drywall ceiling cutout length, add an endcap allowance to each end of a straight run, as follows: Standard flat endcap (D1-D4) – 1/2"; Capsule endcap – 1-3/4"; Dado endcap – 3/16".

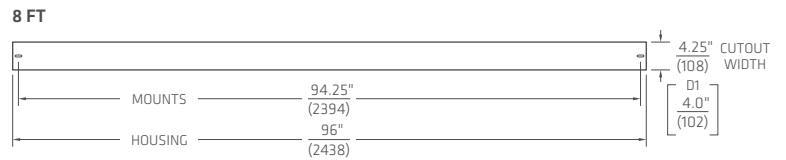
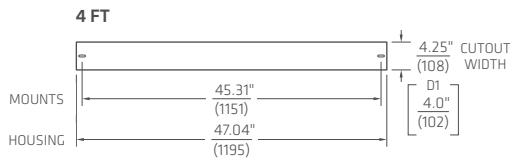
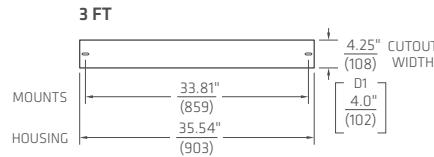
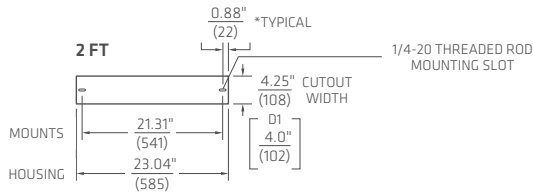

**EXAMPLE OF A DRYWALL CUTOUT FOR A 17' RUN**

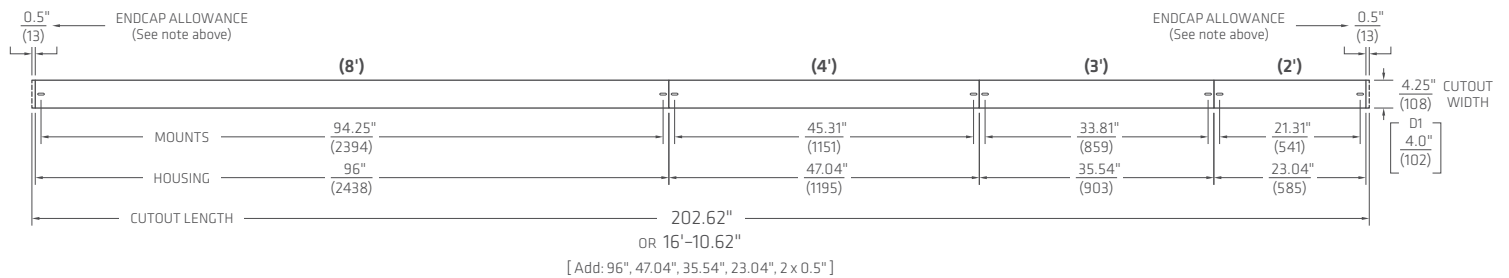

**INSTALLATION NOTES**

- Cutout dimensions apply to all drywall trim options.
- A minimum depth of 5" above ceiling plane or behind wall plane is required.
- Threaded rod or lag bolt mounting is required for ceiling installations only:
  - Ensure 1/4-20 threaded rod length is cut between 3.25" - 4.25" above finished ceiling plane.
  - 2 threaded rods required for each linear housing.

SPECIFICATION DATA  
NOTCH 2 AREA ASYMMETRIC (NT1-A)

## NOTES

## CONSTRUCTION

- 20 ga. satin coat steel housing
- Extruded aluminum flange options available for drywall trim, trimless and T-bar grid ceilings
- White powdercoat or optional black trim

## OPTICAL

- Anidolic optical structures with linear light extraction elements
- Precision extruded high transmittance clear acrylic lenses
- Long life mid-flux LED system designed for typical TM21 lumen maintenance  $\geq$  L90 @ 60,000 h
- Available in CCTs 3000 K, 3500 K or 4000 K with CRI  $\geq$  80 and R9  $\geq$  0, all with color accurate binning  $\leq$  2 SDCM

## ELECTRICAL

- Integral high efficiency multivolt drivers, for 50–60 Hz 120–277 V or 347 V
- Power Factor  $>$  0.90
- Total Harmonic Distortion  $<$  20%
- Dim level: Standard 3%, optional 1% or 0.1%
- Optional Battery Pack delivers 10 W Class 2 rated output for 90 min. Use 12 W input energy to estimate emergency flux, typically 1100–1300 lm (@95–105 lm/W).
- Optional GTD (Generator Transfer Switch), 120–277 V, disables 0–10 V control during emergency for full light output
- Surge Protection: Meets ANSI C82.11 spec and ANSI/IEEE C62.41
- Inrush Current: Meets NEMA 410

## ENVIRONMENTAL &amp; CARE

- Designed for use in dry or damp indoor locations with ambient temperatures of 0–30° C (32–86° F)
- Not suitable for natatorium environments, e.g. swimming pools, hot tubs and saunas. The luminaire may be damaged by chemicals such as chlorine, solvents, ammonia, alcohol or sulfur in the area of operation or in cleaning products. Damage from contaminants is not covered under warranty.
- Clean only by wiping with a slightly water-damp, soft, clean cloth.

## WEIGHT

- Maximum 7 lb/ft (10.4 kg/m) with standard driver
- Maximum 8 lb/ft (11.9 kg/m) with battery pack or 347 V transformer

## WARRANTY

- 5 year limited warranty on all components and workmanship

## INDEPENDENT TESTING

- IESNA LM79
- IESNA LM80 (LED @ 9,000 or 10,000 h)

## APPROVALS

- UL Listed (USA + Canada)
- CCEA Chicago Plenum
- IC Rated
- Lighting Facts®

## CONTROLS &amp; SENSORS

Fluxwerx products are designed for simple integration with a wide range of sensors, lighting controls and building management systems. Many projects incorporate occupancy sensing, daylight harvesting, individual or central adjustment of light levels and luminaire or space monitoring in order to save energy, reduce costs and maximize occupant comfort. Fluxwerx offers a number of standard driver and controller options to support various wired and wireless network protocols.

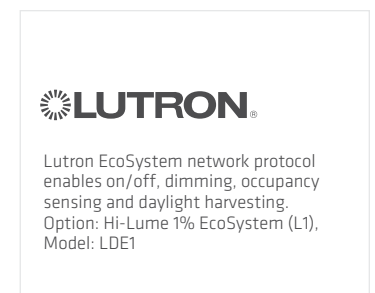
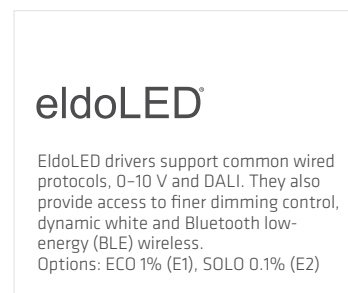
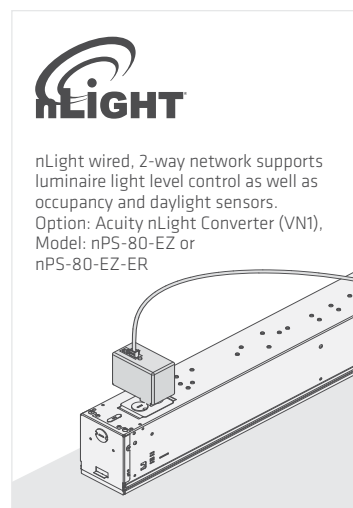
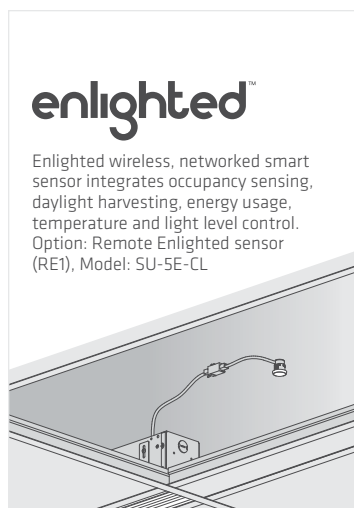

**legrand®** Wattstopper® Pass & Seymour

**LEVITON®** **EATON®** **DISTECH CONTROLS™**

**CRESTRON**

## SPECIFICATION DATA

### NOTCH 2 AREA ASYMMETRIC (NT1-A)

#### PERFORMANCE DATA

A 5 W/ft	CCT	LIGHT (lm/ft)	ENERGY (W/ft)	EFFICACY (lm/W)	(CRI)	COLOR ACCURACY (R9)	(SDCM)
VERSION <b>NT1-AA40</b>	4000 K	468	4.69	99.8	82.8	6.3	< 2
	3500 K	462	4.69	98.4	82.8	6.3	
	REPORT 11596156.01	3000 K	455	4.69	97.0	82.9	
B 6 W/ft	CCT	LIGHT (lm/ft)	ENERGY (W/ft)	EFFICACY (lm/W)	(CRI)	COLOR ACCURACY (R9)	(SDCM)
VERSION <b>NT1-AB40</b>	4000 K	604	5.92	102.0	82.8	6.3	< 2
	3500 K	596	5.92	100.6	82.8	6.3	
	REPORT 11921916.07	3000 K	587	5.92	99.2	82.9	

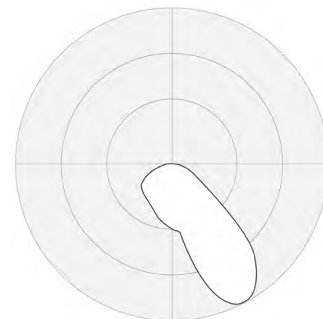

100% Dn Asymmetric  
Notch 2  
NT1-A

Integrating Sphere and Photometric results at 4000K by an independent accredited testing laboratory per IES LM-79-2008 and ANSI C78.377-2011. Results for 3000K and 3500K scaled based on integrating sphere results for NT1-A 23W (B) and NT1-B. Candelpower Distribution scaled per total lumens of Integrating Sphere results.

#### NT1-AA40

LED lighting facts®	
A Program of the U.S. DOE	
Light Output (Lumens)	1776
Watts	19.15
Lumens per Watt (Efficacy)	92.74
Color Accuracy Color Rendering Index (CRI)	83
Light Color Correlated Color Temperature (CCT)	4000 (Bright White)
	
<small>All results are according to IESNA LM-79-2008. Approved Method for the Electrical and Photometric Testing of Solid-State Lighting. The U.S. Department of Energy (DOE) verifies product test data and results.</small>	
<small>Visit <a href="http://www.lightingfacts.com">www.lightingfacts.com</a> for the Label Reference Guide.</small>	
<small>Registration Number: 3A4K-SGLNLD (10/29/2017)</small>	
<small>Model Number: NT1-LA04A40P1F2E1E2E3E49804 (04/2017)</small>	
<small>Type: Luminaire - Linear</small>	

#### NT1-AB40

LED lighting facts®	
A Program of the U.S. DOE	
Light Output (Lumens)	2123
Watts	23.3
Lumens per Watt (Efficacy)	91.12
Color Accuracy Color Rendering Index (CRI)	82
Light Color Correlated Color Temperature (CCT)	4000 (Bright White)
	
<small>All results are according to IESNA LM-79-2008. Approved Method for the Electrical and Photometric Testing of Solid-State Lighting. The U.S. Department of Energy (DOE) verifies product test data and results.</small>	
<small>Visit <a href="http://www.lightingfacts.com">www.lightingfacts.com</a> for the Label Reference Guide.</small>	
<small>Registration Number: 3A4K-KRBSZU (10/19/2017)</small>	
<small>Model Number: NT1-LA04A40P1F2E1E2E3E49804 (04/2017)</small>	
<small>Type: Luminaire - Linear</small>	