

FLUXWERX®

SPECIFICATION DATA NOTCH 4 PATTERN VSI SYM. (NF2P-B)

PATTERN CATALOG

PROJECT

NOTES



100% Dn VSI Symmetric

CROSS SECTION

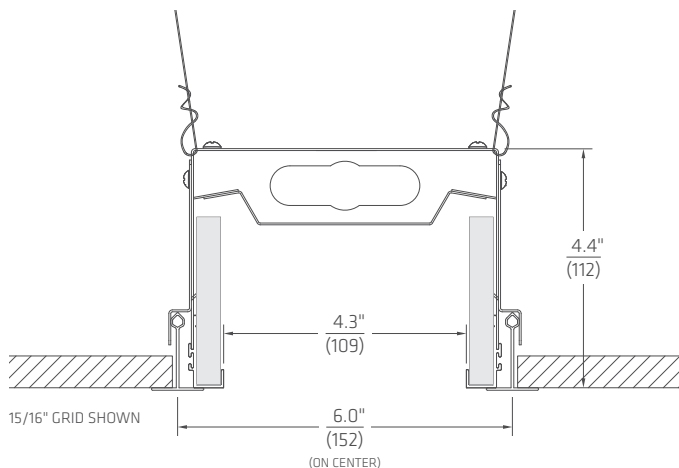

CEILING & TRIM

DRYWALL TRIM



DRYWALL TRIMLESS



GRID



PERFORMANCE SUMMARY

	A	B
Light (lm/ft)	525	675
Energy (W/ft)	7.25	9.5
Efficacy (lm/W)	72	69
Color Rendering (CRI)	80+	
Color Accuracy (SDCM)	< 2	
Lumen Maintenance (hr)	L90 per TM-21: >60,000 L70 estimate: >200,000	

Summary values are nominal and based on 4000K CCT.

FEATURES

- 4-1/3" open aperture design with fully luminous interior. No horizontal lenses or diffusers.
- Anidolic optics provide shielded, precisely controlled optical distributions, for low glare and wide row spacing.
- Vertical surface illumination (VSI) symmetric and asymmetric distributions can deliver 2:1 vertical uniformity and over 30 fc onto walls and stacks.
- Length increments of 1' in drywall or 2' in T-grid ceilings.
- Dedicated corners make it easy to create horizontal patterns.
- Optional Dado drywall endcap creates a unique boundary for the line of light.
- 6" Armstrong TechZone® or 6" USG Logix® T-grid compatible.



SPECIFICATION DATA
NOTCH 4 PATTERN VSI SYM. (NF2P-B)

PATTERN CATALOG #

NOTE: Some options, such as Battery Packs and Alternative Wiring are shown per side.

PATTERN CORNER

PATTERN SIDES

PATTERNS

For patterns, design your own layout using the trim and corner option available or choose from our predefined shapes for simpler specification.

NOTE: Minimum corner to corner length – 4 ft in drywall (4' x 4' square) | 6 ft in grid (6' x 6' square)

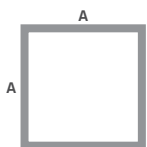

P0 – SQUARE



P1 – RECTANGLE

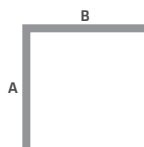

P2 – 2 SIDES | 1 CORNER

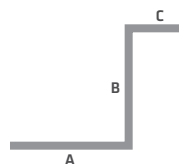

P3 – 3 SIDES | 2 CORNERS

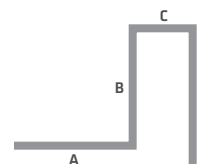

P4 – 4 SIDES | 3 CORNERS

CORNER FIXTURE

Intersecting sections can be used as standalone fixtures or combined with rows to create illuminated ceiling designs and patterns of light in limitless combinations.

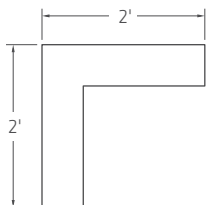

CORNER (LC)
 – WALL OR CEILING

SPECIFICATION DATA
NOTCH 4 PATTERN VSI SYM. (NF2P-B)

ORDER GUIDE

1	2	3	4	5	6	7	8	9	OPTIONS	CONTROLS
NF2			B							

1 FAMILY	2 VERSION	3 TRIM / CEILING	4 DISTRIBUTION	5 ENERGY ²
NF2 Notch 4 Vertical Surface Illumination (VSI)	L Linear Row R Pattern Side/Corner PATTERN ¹ P0 Square P1 Rectangle P2 2-rows 1-corner P3 3-rows 2-corner P4 4-rows 3-corner P5 5-rows 4-corner <small>¹ Other pattern options available. See previous page or consult factory.</small>	D1 Drywall – Trim Flange D2 Drywall – Trimless D3 Drywall – Drop Radius D4 Drywall – Drop Square G1 Grid – 9/16" or 15/16" Flat-T G1 9/16" Tegular or Bolt-Slot G1 6" Armstrong TechZone® or 6" USG Logix®	B Symmetric	C 7.25 W/ft D 9.5 W/ft <small>² Add 1 W/ft for 347 V with E1-4/L1.</small>

6 CCT	7 DRIVER	8 VOLTAGE	9 LENGTH ⁵
30 3000 K 35 3500 K 40 4000 K	F1 Non-Dim F2 0-10 V Dim 3% E1 eldoLED ECO 0-10 V Dim 1% E2 eldoLED SOLO 0-10 V Dim 0.1% E3 eldoLED ECO DALI Dim 1% E4 eldoLED SOLO DALI Dim 0.1% L1 Lutron Hi-Lume 1% EcoSystem (LDE1)	M 120-277 V 3 347 V ⁴ <small>⁴ 347 V Driver for F1. 347 V Transformer & Driver for E1-4/L1.</small>	XX Drywall – Specify 1ft Increments XX Grid – Specify 2 ft Increments LC Corner (Flat 2 ft x 2 ft) <small>⁵ Minimum is 2 feet.</small>

OPTIONS		CONTROLS	
WIRING & EMERGENCY A Alternate Wiring (AV switching) ⁷ B Battery Pack ⁸ F 6' Flex Whip (in 1st module) H Emergency Switching (GTD or Controller) M EM or NL Wiring (2nd neutral) ⁷ T Throughwire Circuit U Throughwire (w/neutral)	LAYOUT & FINISH C Chicago Plenum E Dado Endcap ⁹ K Black Trim and Endcap	SENSORS & CONTROLLERS RE1 Remote Enlighted Smart Sensor VN1 Acuity nLight Converter	
<small>⁷ Splits 8 ft module into two 4 ft circuits. ⁸ Available for 120-277 V in linear 4 or 8 ft modules.</small>		<small>⁹ Available with D2 trim option. Default option is to install in one end only. Call factory for options.</small>	

PRODUCT DETAILS

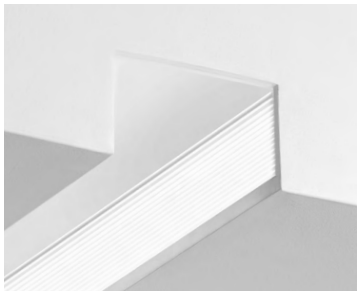

LINEAR ANIDOLIC OPTIC

TRIM OPTIONS

TRIM



D1 - DRYWALL TRIM FLANGE

TRIMLESS



D2 - DRYWALL TRIMLESS



OPTIONAL - DADO ENDCAP

DROP TRIM



D3 - DRYWALL DROP RADIUS



D4 - DRYWALL DROP SQUARE

GRID



G1 - 9/16" GRID FLAT T



G1 - 15/16" GRID FLAT T

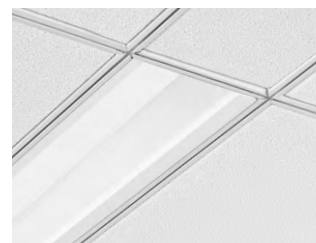

G1 - 9/16" TEGULAR | SLOT GRID

NOTE: Use G1 for 6" Armstrong TechZone® or 6" USG Logix®

DIMENSIONS

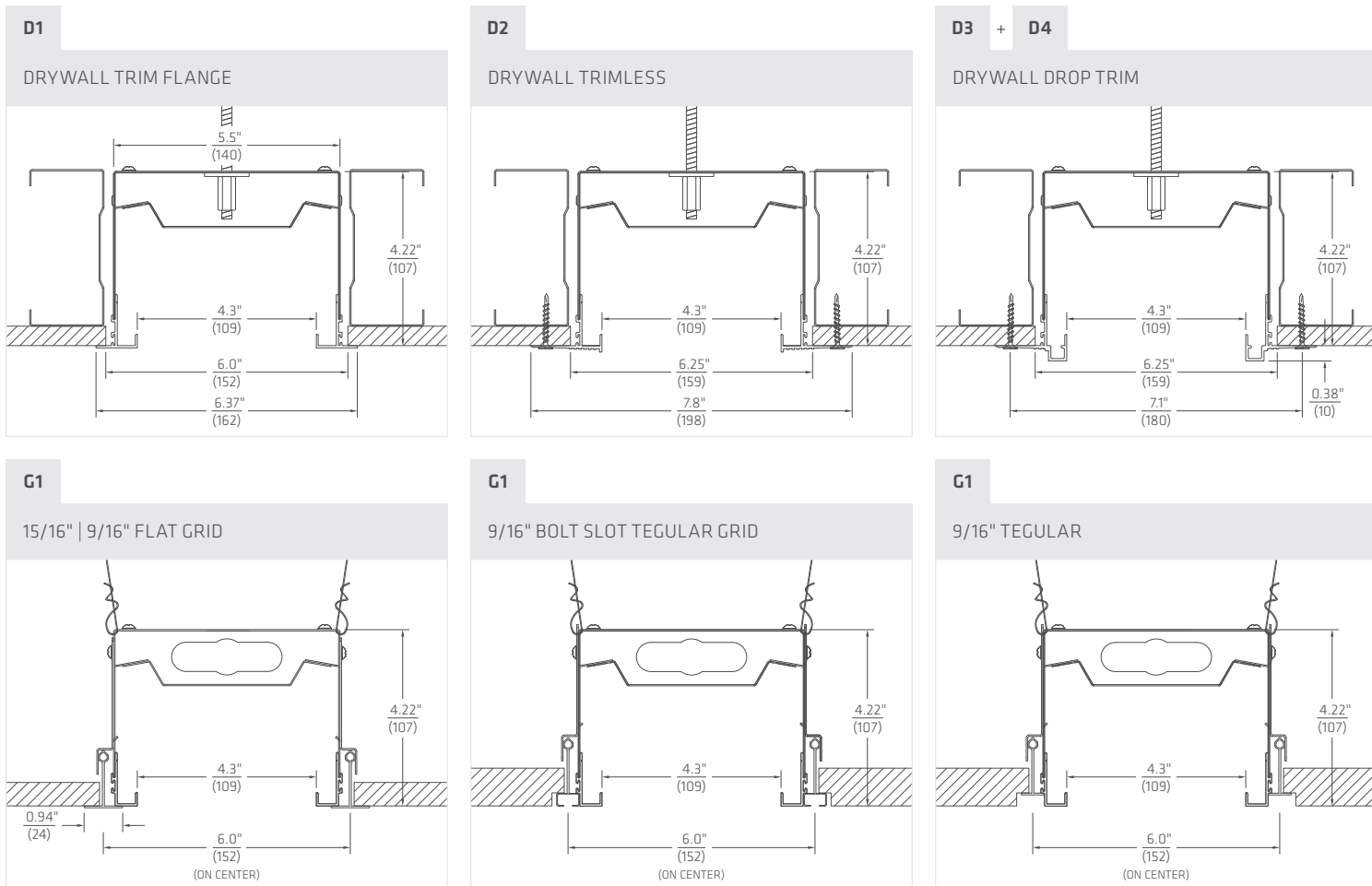

Grid (G1) is 6" Armstrong TechZone® and 6" USG Logix® T-grid compatible.

OPTION E

DADO ENDCAP

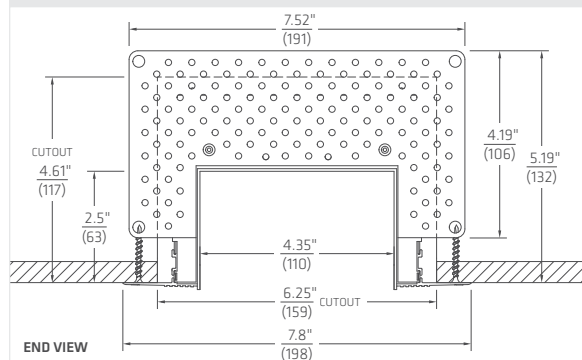

LINEAR ROWS & FIXTURES

Continuous rows are available in nominal 1' increments in drywall ceilings and in 2' increments on-grid for T-bar ceilings. Standalone fixtures are available in 2', 3', 4', or 8' sizes.

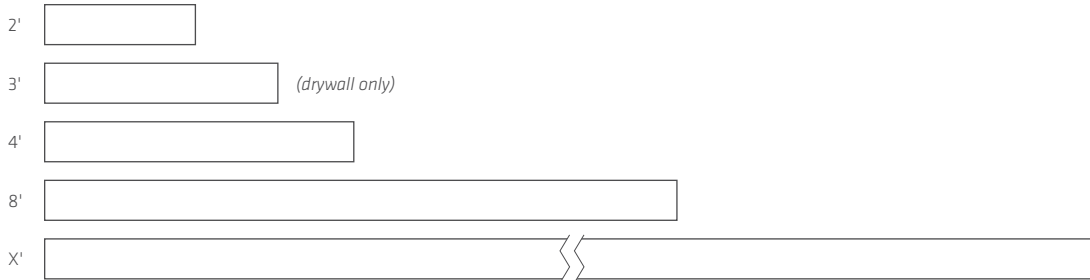

NOTE: Run lengths are nominal and vary with ceiling condition and trim selections.

DRYWALL CUTOUT DIMENSIONS

To determine the overall drywall ceiling cutout length, add an endcap allowance to each end of a straight run, as follows: Standard flat endcap (D1-D4) – 1/2"; Dado endcap – 3/16".

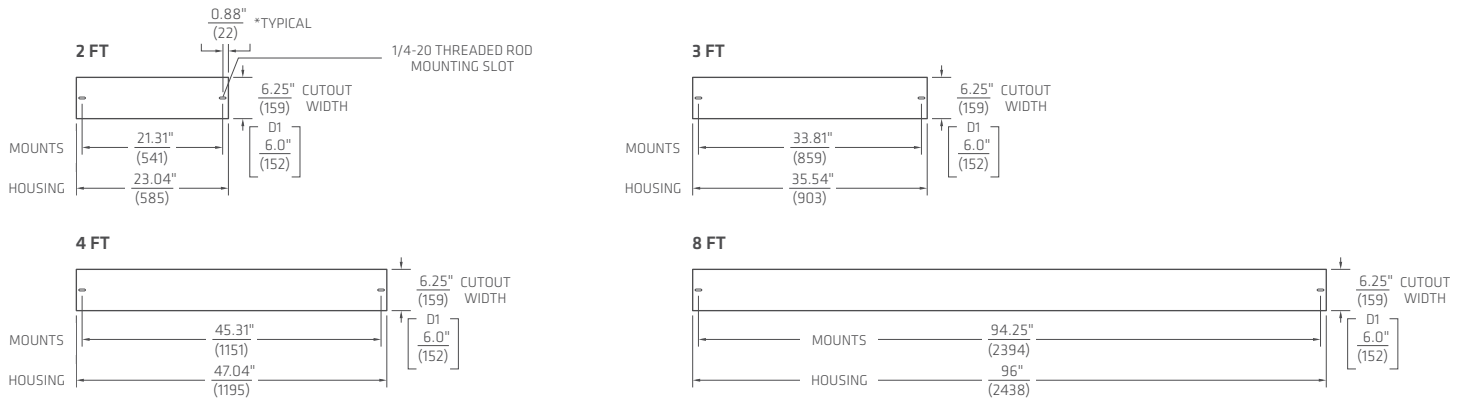

EXAMPLE OF A DRYWALL CUTOUT FOR A 17' RUN

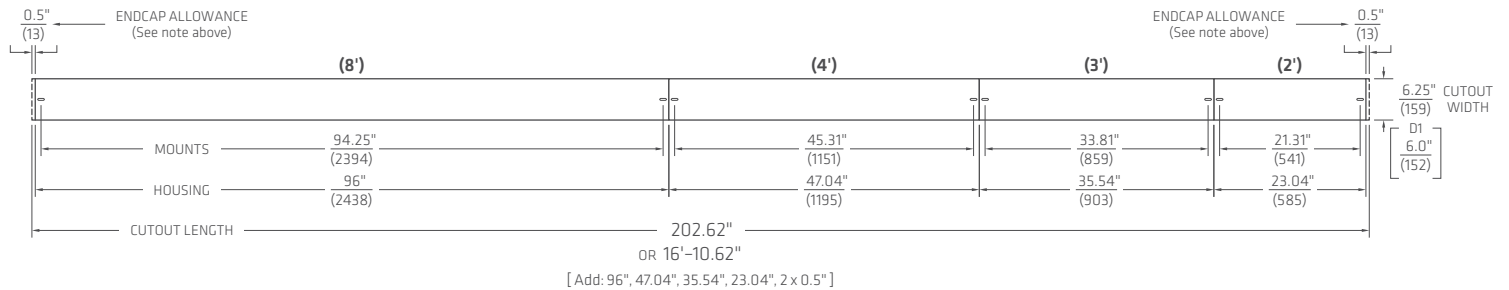

INSTALLATION NOTES

- Cutout dimensions apply to all drywall trim options.
- A minimum depth of 4.75" above ceiling plane or behind wall plane is required.
- Threaded rod or lag bolt mounting is required for ceiling installations only:
 - Ensure 1/4-20 threaded rod length is cut between 3.125"–3.75" above finished ceiling plane.
 - 2 threaded rods required for each linear housing.

DRYWALL CUTOUT DIMENSIONS

To determine the overall drywall ceiling cutout length, add an endcap allowance to the termination legs of an open pattern, as follows:
 Standard flat endcap (D1-D4) – 1/2"; Dado endcap – 3/16".

For corner legs of a pattern, DO NOT add an endcap allowance. Instead, use centerline dimensions and the relevant trim cutout width to determine the opening.

CORNER (LC)

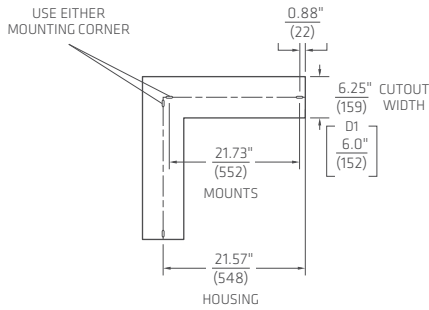

**EXAMPLE DRYWALL PATTERN CUTOUT:
 (P3) U-SHAPE 4' X 12' X 6'**

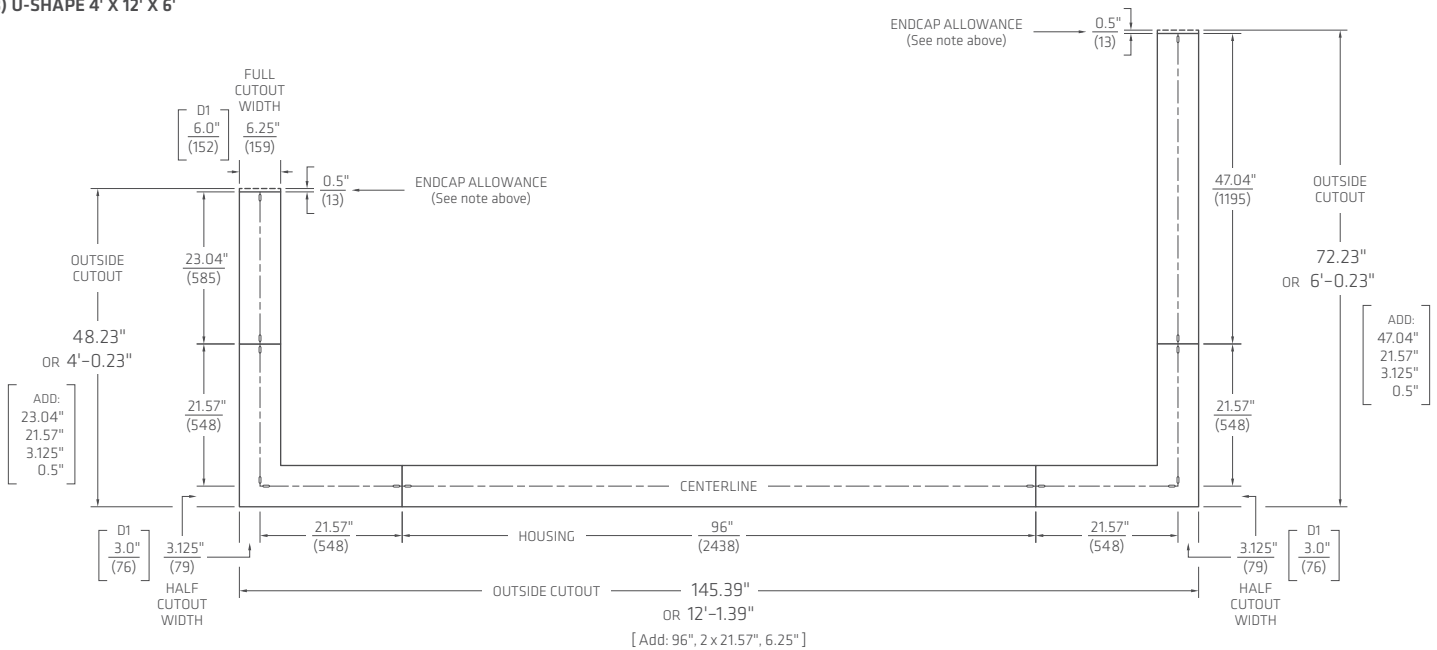

INSTALLATION NOTES

- Cutout dimensions apply to all drywall trim options.
- A minimum depth of 4.75" above ceiling plane or behind wall plane is required.
- For patterns, squares and rectangles, use centerline dimensions with trim cutout width to determine the opening.
- Threaded rod or lag bolt mounting is required for ceiling installations only:
 - Ensure 1/4-20 threaded rod length is cut between 3.125"–3.75" above finished ceiling plane.
 - 2 threaded rods required for each linear housing (3 for Corners).

SPECIFICATION DATA

NOTCH 4 PATTERN VSI SYM. (NF2P-B)

NOTES

CONSTRUCTION

- 20 ga. satin coat steel housing
- Extruded aluminum flange options available for drywall trim, trimless and T-bar grid ceilings
- White powdercoat or optional black trim

OPTICAL

- Anidolic optical structures with linear light extraction elements
- Precision extruded high transmittance clear acrylic lenses
- Long life mid-flux LED system designed for typical TM21 lumen maintenance \geq L90 @ 60,000 h
- Available in CCTs 3000 K, 3500 K or 4000 K with CRI \geq 80 and R9 \geq 0, all with color accurate binning \leq 2 SDCM

ELECTRICAL

- Integral high efficiency multivolt drivers, for 50–60 Hz 120–277 V or 347 V
- Power Factor $>$ 0.90
- Total Harmonic Distortion $<$ 20%
- Dim level: Standard 3%, optional 1% or 0.1%
- Optional Battery Pack delivers 10 W Class 2 rated output for 90 min. Use 12 W input energy to estimate emergency flux, typically 800–900 lm (@65–75 lm/W).
- Optional GTD (Generator Transfer Switch), 120–277 V, disables 0–10 V control during emergency for full light output
- Surge Protection: Meets ANSI C82.11 spec and ANSI/IEEE C62.41
- Inrush Current: Meets NEMA 410

ENVIRONMENTAL & CARE

- Designed for use in dry or damp indoor locations with ambient temperatures of 0–30° C (32–86° F)
- Not suitable for natatorium environments, e.g. swimming pools, hot tubs and saunas. The luminaire may be damaged by chemicals such as chlorine, solvents, ammonia, alcohol or sulfur in the area of operation or in cleaning products. Damage from contaminants is not covered under warranty.
- Clean only by wiping with a slightly water-damp, soft, clean cloth.

WEIGHT

- Maximum 8 lb/ft (11.9 kg/m) with standard driver
- Maximum 9 lb/ft (13.4 kg/m) with battery pack or 347 V transformer

WARRANTY

- 5 year limited warranty on all components and workmanship

INDEPENDENT TESTING

- IESNA LM79
- IESNA LM80 (LED @ 9,000 or 10,000 h)

APPROVALS

- UL Listed (USA + Canada)
- CCEA Chicago Plenum
- IC Rated
- Lighting Facts®

CONTROLS & SENSORS

Fluxwerx products are designed for simple integration with a wide range of sensors, lighting controls and building management systems. Many projects incorporate occupancy sensing, daylight harvesting, individual or central adjustment of light levels and luminaire or space monitoring in order to save energy, reduce costs and maximize occupant comfort. Fluxwerx offers a number of standard driver and controller options to support various wired and wireless network protocols.

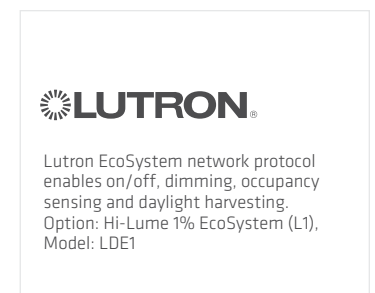
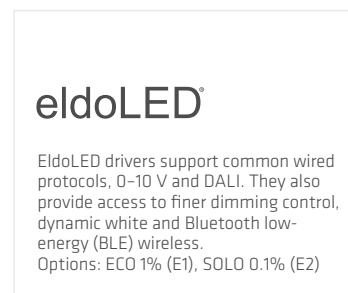
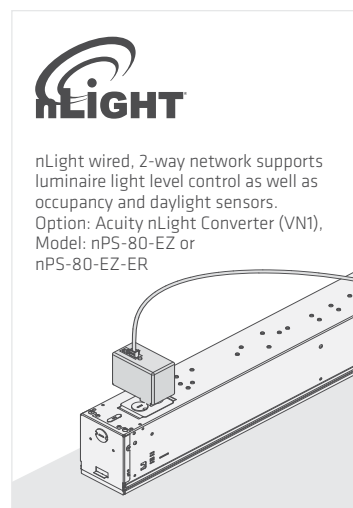
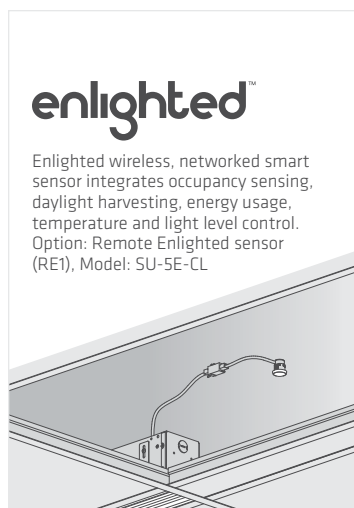

legrand® Wattstopper® Pass & Seymour

LEVITON® **EATON®** **DISTECH CONTROLS™**

CRESTRON®

SPECIFICATION DATA

NOTCH 4 PATTERN VSI SYM. (NF2P-B)

PERFORMANCE DATA

C 7.25 W/ft	CCT	LIGHT (lm/ft)	ENERGY (W/ft)	EFFICACY (lm/W)	(CRI)	COLOR ACCURACY (R9)	(SDCM)
VERSION NF2-BC40	4000 K	518	7.16	72.4	83.6	11.4	< 2
	3500 K	508	7.16	71.0	83.6	11.4	
	REPORT 11651177.11	3000 K	498	7.16	69.6	82.1	

D 9.5 W/ft	CCT	LIGHT (lm/ft)	ENERGY (W/ft)	EFFICACY (lm/W)	(CRI)	COLOR ACCURACY (R9)	(SDCM)
VERSION NF2-BD40	4000 K	670	9.66	69.4	83.6	11.2	< 2
	3500 K	657	9.66	68.1	83.6	11.4	
	REPORT 116651177.14	3000 K	645	9.63	66.9	82.1	

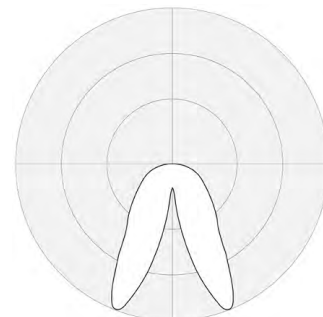

100% Dn VSI Symmetric
Notch 4
NF2-B

Integrating Sphere and Photometric results at 4000K by an independent accredited testing laboratory per IES LM-79-2008 and ANSI C78.377-2011. Results for 3000K and 3500K scaled based on integrating sphere results at 38W (D). Candlpower Distribution scaled per total lumens of Integrating Sphere results.

NF2-BC40

LED lighting facts®	
A Program of the U.S. DOE	
Light Output (Lumens)	2073
Watts	28.62
Lumens per Watt (Efficacy)	72.43
Color Accuracy Color Rendering Index (CRI)	83
Light Color Correlated Color Temperature (CCT)	4000 (Bright White)
	
<small>All results are according to IESNA LM-79-2008. Approved Method for the Electrical and Photometric Testing of Solid-State Lighting. The U.S. Department of Energy (DOE) verifies product test data and results.</small>	
<small>Visit www.lightingfacts.com for the Label Reference Guide.</small>	
<small>Registration Number: XAAR-EMGAEX (1/31/2018)</small>	
<small>Model Number: NF2L040C40P1F2E162N3E4304</small>	
<small>Type: Luminaire - Linear</small>	

NF2-BD40

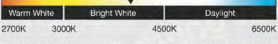
LED lighting facts®	
A Program of the U.S. DOE	
Light Output (Lumens)	2681
Watts	38.62
Lumens per Watt (Efficacy)	69.42
Color Accuracy Color Rendering Index (CRI)	83
Light Color Correlated Color Temperature (CCT)	4000 (Bright White)
	
<small>All results are according to IESNA LM-79-2008. Approved Method for the Electrical and Photometric Testing of Solid-State Lighting. The U.S. Department of Energy (DOE) verifies product test data and results.</small>	
<small>Visit www.lightingfacts.com for the Label Reference Guide.</small>	
<small>Registration Number: XAAR-RV1351 (1/31/2018)</small>	
<small>Model Number: NF2L040B40P1F3E162N3E4304</small>	
<small>Type: Luminaire - Linear</small>	