

SPECIFICATION DATA
NOTCH 4 AREA ASYMMETRIC (NF1-A)

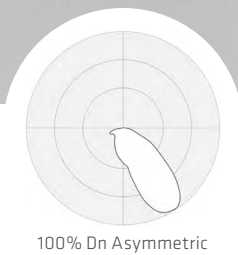

D2 – DRYWALL TRIMLESS SHOWN WITH (E) DADO ENDCAP OPTION



CROSS SECTION

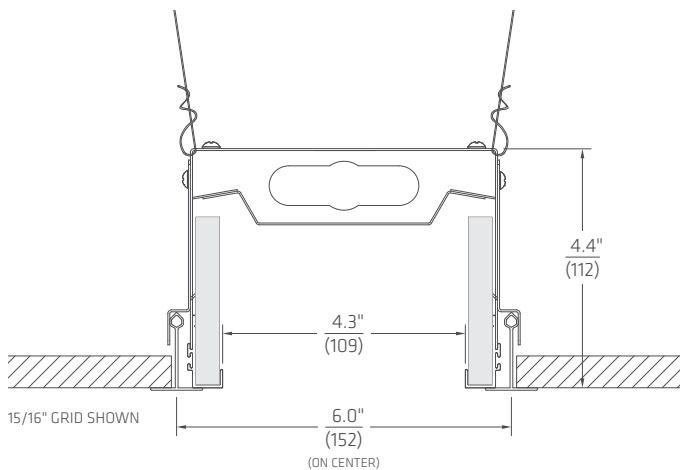

CEILING & TRIM

DRYWALL TRIM



DRYWALL TRIMLESS



GRID



PATTERN CATALOG #

[Blank input field for Pattern Catalog #]

PROJECT

[Blank input field for Project]

NOTES

[Blank input field for Notes]

PERFORMANCE SUMMARY

	A	B
Light (lm/ft)	475	600
Energy (W/ft)	5	6
Efficacy (lm/W)	100	102
Color Rendering (CRI)	80+	
Color Accuracy (SDCM)	< 2	
Lumen Maintenance (hr)	L90 per TM-21: >60,000 L70 estimate: >200,000	

Summary values are nominal and based on 4000K CCT.

FEATURES

- 4-1/3" open aperture design with fully luminous interior. No horizontal lenses or diffusers.
- Anidolic optics provide shielded, precisely controlled optical distributions, for low glare and wide row spacing.
- Up to 12 ft o.c. spacing, delivering 40 fc at less than 0.5 W/ft².
- Length increments of 1' in drywall or 2' in T-grid ceilings.
- Dedicated corners make it easy to create horizontal patterns.
- Optional Dado drywall endcap creates a unique boundary for the line of light.
- 6" Armstrong TechZone® or 6" USG Logix® T-grid compatible.



SPECIFICATION DATA
NOTCH 4 AREA ASYMMETRIC (NF1-A)

ORDER GUIDE

1	2	3	4	5	6	7	8	9	OPTIONS	CONTROLS
NF1			A							

1 FAMILY	2 VERSION	3 TRIM / CEILING	4 DISTRIBUTION	5 ENERGY ²
NF1 Notch 4 Area	L Linear Row R Pattern Side/Corner PATTERN ¹ P0 Square P1 Rectangle P2 2-rows 1-corner P3 3-rows 2-corner P4 4-rows 3-corner P5 5-rows 4-corner <small>¹ Other pattern options available. See previous page or consult factory.</small>	D1 Drywall – Trim Flange D2 Drywall – Trimless D3 Drywall – Drop Radius D4 Drywall – Drop Square G1 Grid – 9/16" or 15/16" Flat-T G1 9/16" Tegular or Bolt-Slot G1 6" Armstrong TechZone® or 6" USG Logix®	A Asymmetric	A 5 W/ft B 6 W/ft <small>² Add 1 W/ft for 347 V with E1-4/L1.</small>

6 CCT	7 DRIVER	8 VOLTAGE	9 LENGTH ⁵
30 3000 K 35 3500 K 40 4000 K	F1 Non-Dim F2 0-10 V Dim 3% E1 eldoLED ECO 0-10 V Dim 1% E2 eldoLED SOLO 0-10 V Dim 0.1% E3 eldoLED ECO DALI Dim 1% E4 eldoLED SOLO DALI Dim 0.1% L1 Lutron Hi-Lume 1% EcoSystem (LDE1)	M 120-277 V 3 347 V ⁴ <small>⁴ 347 V Driver for F1. 347 V Transformer & Driver for E1-4/L1.</small>	XX Drywall – Specify 1ft Increments XX Grid – Specify 2 ft Increments LC Corner (Flat 2 ft x 2 ft) <small>⁵ Minimum is 2 feet.</small>

OPTIONS		CONTROLS	
WIRING & EMERGENCY A Alternate Wiring (AV switching) ⁷ B Battery Pack ⁸ F 6' Flex Whip (in 1st module) H Emergency Switching (GTD or Controller) M EM or NL Wiring (2nd neutral) ⁷ T Throughwire Circuit U Throughwire (w/neutral) <small>⁷ Splits 8 ft module into two 4 ft circuits. ⁸ Available for 120-277 V in linear 4 or 8 ft modules.</small>	LAYOUT & FINISH C Chicago Plenum E Dado Endcap ⁹ K Black Trim and Endcap <small>⁹ Available with D2 trim option. Default option is to install in one end only. Call factory for options.</small>	SENSORS & CONTROLLERS RE1 Remote Enlighted Smart Sensor VN1 Acuity nLight Converter	

PRODUCT DETAILS



LINEAR ANIDOLIC OPTIC

TRIM OPTIONS

TRIM



D1 - DRYWALL TRIM FLANGE

TRIMLESS



D2 - DRYWALL TRIMLESS

DROP TRIM



D3 - DRYWALL DROP RADIUS

GRID



G1 - 9/16" GRID FLAT T



OPTIONAL - DADO ENDCAP



D4 - DRYWALL DROP SQUARE



G1 - 15/16" GRID FLAT T

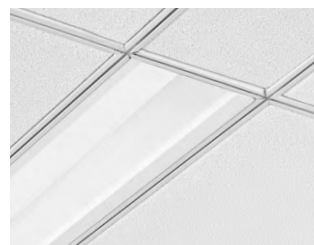

G1 - 9/16" TEGULAR | SLOT GRID

NOTE: Use G1 for 6" Armstrong TechZone® or 6" USG Logix®

DIMENSIONS

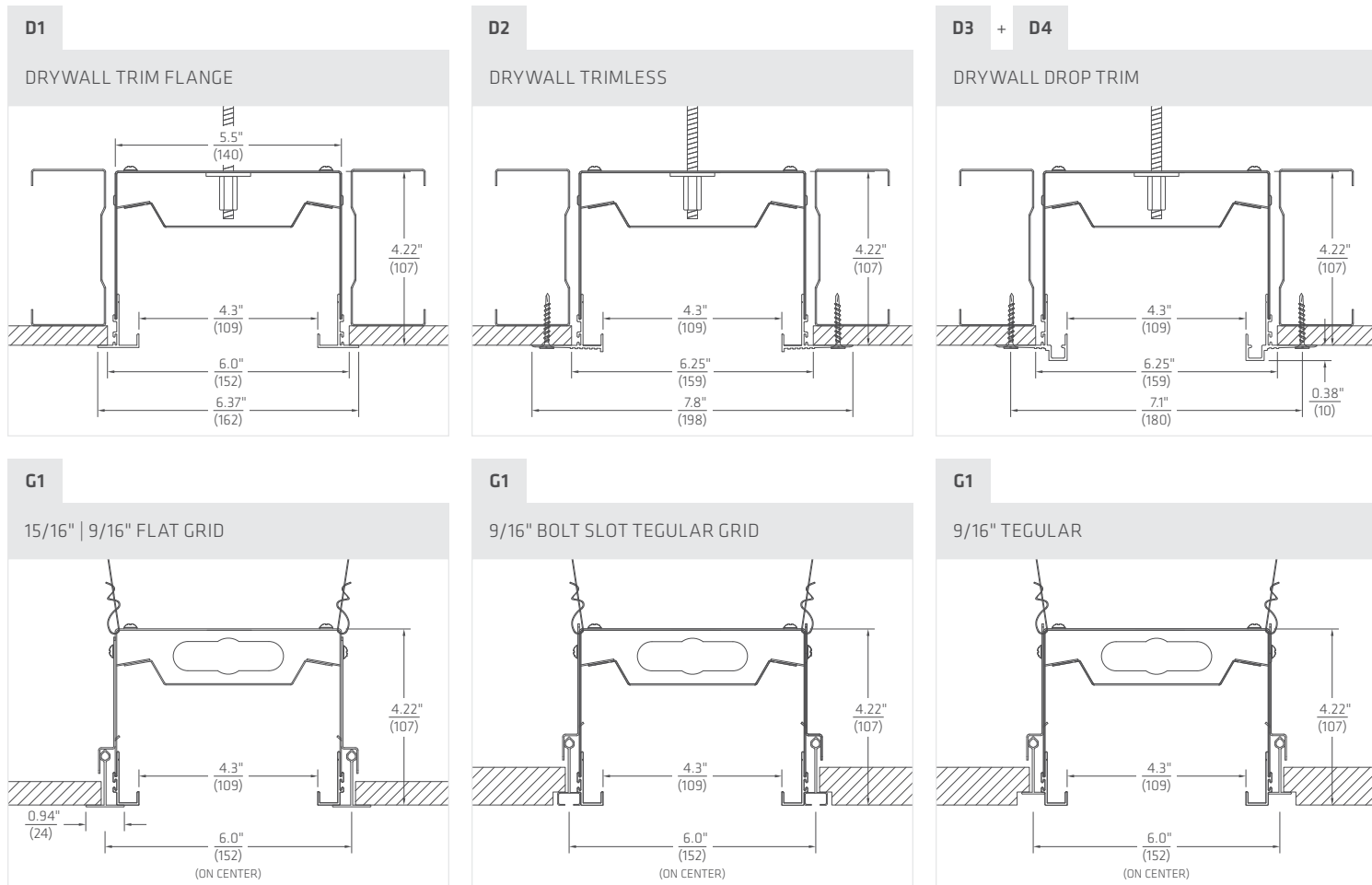

Grid (**G1**) is 6" Armstrong TechZone® and 6" USG Logix® T-grid compatible.

OPTION E

DADO ENDCAP

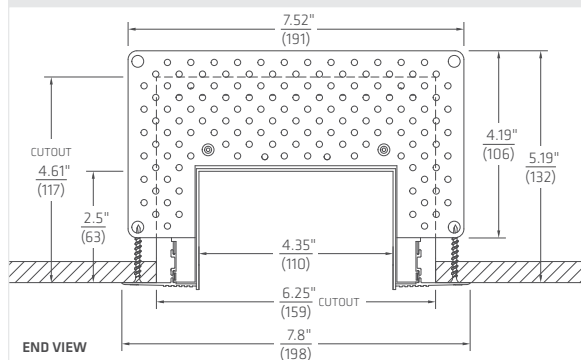

LINEAR ROWS & FIXTURES

Continuous rows are available in nominal 1' increments in drywall ceilings and in 2' increments on-grid for T-bar ceilings. Standalone fixtures are available in 2', 3', 4', or 8' sizes.

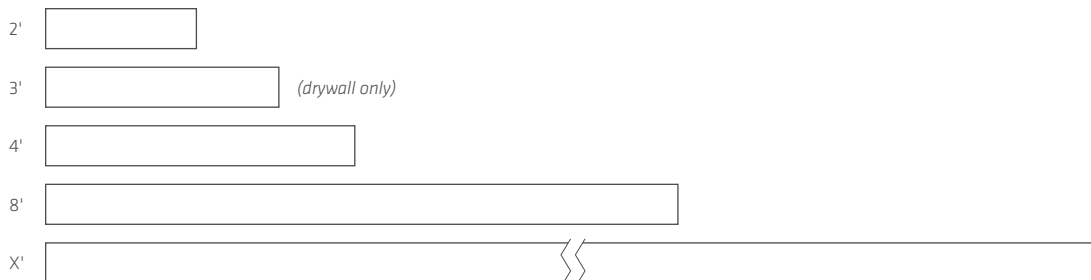

NOTE: Run lengths are nominal and vary with ceiling condition and trim selections.

DRYWALL CUTOUT DIMENSIONS

To determine the overall drywall ceiling cutout length, add an endcap allowance to each end of a straight run, as follows: Standard flat endcap (D1-D4) – 1/2"; Dado endcap – 3/16".

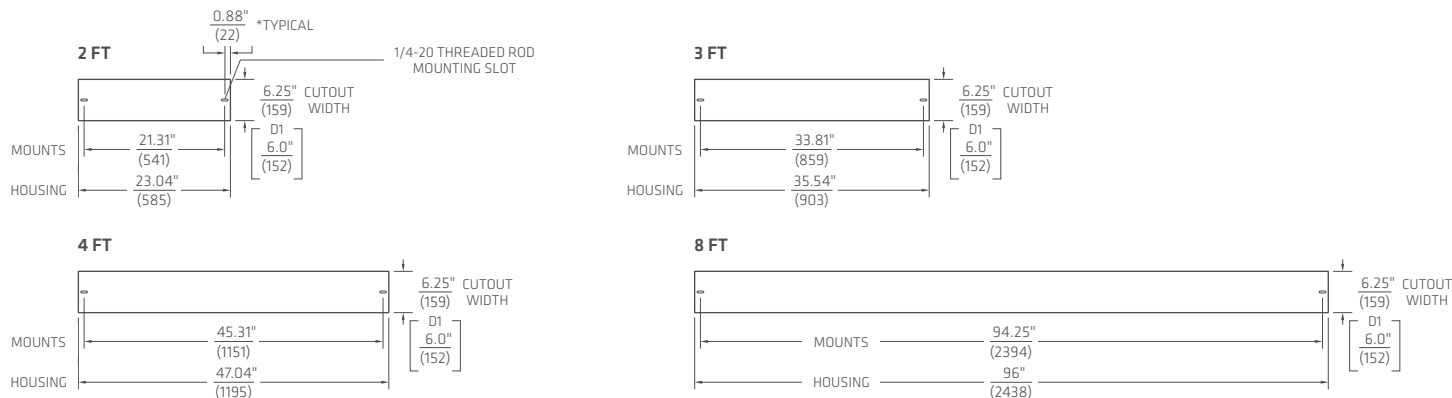

EXAMPLE OF A DRYWALL CUTOUT FOR A 17' RUN

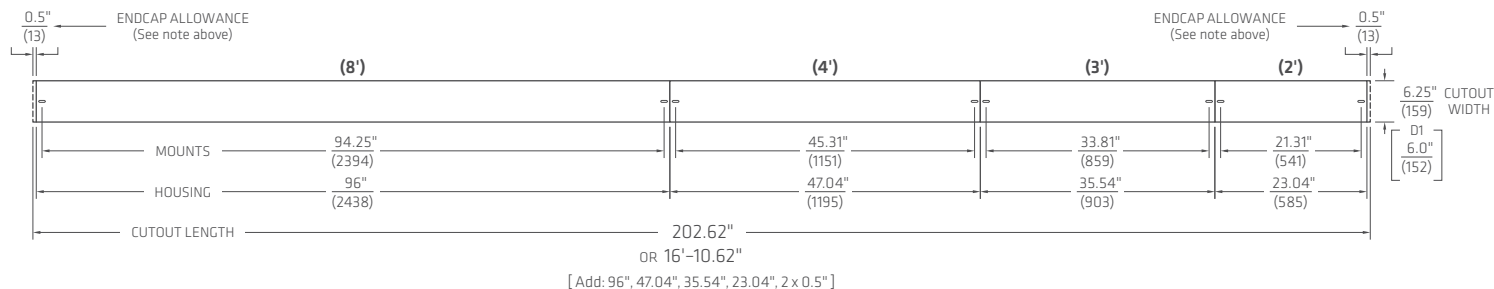

INSTALLATION NOTES

- Cutout dimensions apply to all drywall trim options.
- A minimum depth of 4.75" above ceiling plane or behind wall plane is required.
- Threaded rod or lag bolt mounting is required for ceiling installations only:
 - Ensure 1/4-20 threaded rod length is cut between 3.125" – 3.75" above finished ceiling plane.
 - 2 threaded rods required for each linear housing.

SPECIFICATION DATA

NOTCH 4 AREA ASYMMETRIC (NF1-A)

NOTES

CONSTRUCTION

- 20 ga. satin coat steel housing
- Extruded aluminum flange options available for drywall trim, trimless and T-bar grid ceilings
- White powdercoat or optional black trim

OPTICAL

- Anidolic optical structures with linear light extraction elements
- Precision extruded high transmittance clear acrylic lenses
- Long life mid-flux LED system designed for typical TM21 lumen maintenance \geq L90 @ 60,000 h
- Available in CCTs 3000 K, 3500 K or 4000 K with CRI \geq 80 and R9 \geq 0, all with color accurate binning \leq 2 SDCM

ELECTRICAL

- Integral high efficiency multivolt drivers, for 50–60 Hz 120–277 V or 347 V
- Power Factor $>$ 0.90
- Total Harmonic Distortion $<$ 20%
- Dim level: Standard 3%, optional 1% or 0.1%
- Optional Battery Pack delivers 10 W Class 2 rated output for 90 min. Use 12 W input energy to estimate emergency flux, typically 1100–1300 lm (@95–105 lm/W).
- Optional GTD (Generator Transfer Switch), 120–277 V, disables 0–10 V control during emergency for full light output
- Surge Protection: Meets ANSI C82.11 spec and ANSI/IEEE C62.41
- Inrush Current: Meets NEMA 410

ENVIRONMENTAL & CARE

- Designed for use in dry or damp indoor locations with ambient temperatures of 0–30° C (32–86° F)
- Not suitable for natatorium environments, e.g. swimming pools, hot tubs and saunas. The luminaire may be damaged by chemicals such as chlorine, solvents, ammonia, alcohol or sulfur in the area of operation or in cleaning products. Damage from contaminants is not covered under warranty.
- Clean only by wiping with a slightly water-damp, soft, clean cloth.

WEIGHT

- Maximum 8 lb/ft (11.9 kg/m) with standard driver
- Maximum 9 lb/ft (13.4 kg/m) with battery pack or 347 V transformer

WARRANTY

- 5 year limited warranty on all components and workmanship

INDEPENDENT TESTING

- IESNA LM79
- IESNA LM80 (LED @ 9,000 or 10,000 h)

APPROVALS

- UL Listed (USA + Canada)
- CCEA Chicago Plenum
- IC Rated
- Lighting Facts®

CONTROLS & SENSORS

Fluxwerx products are designed for simple integration with a wide range of sensors, lighting controls and building management systems. Many projects incorporate occupancy sensing, daylight harvesting, individual or central adjustment of light levels and luminaire or space monitoring in order to save energy, reduce costs and maximize occupant comfort. Fluxwerx offers a number of standard driver and controller options to support various wired and wireless network protocols.

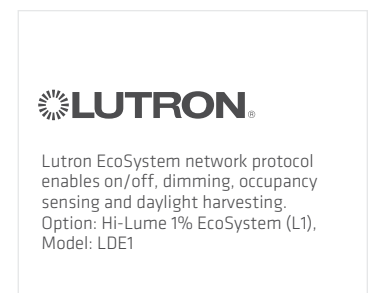
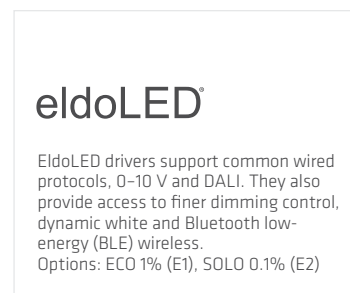
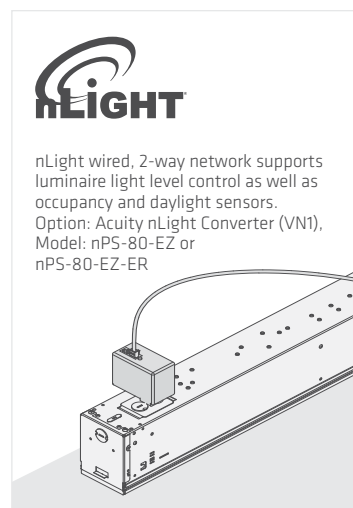
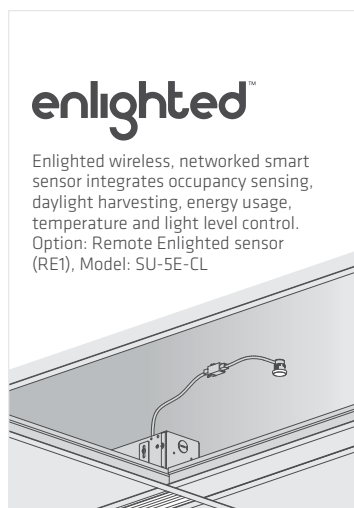

legrand® Wattstopper® Pass & Seymour

LEVITON® EATON® DISTECH CONTROLS™

CRESTRON

SPECIFICATION DATA

NOTCH 4 AREA ASYMMETRIC (NF1-A)

PERFORMANCE DATA

A 5 W/ft	CCT	LIGHT (lm/ft)	ENERGY (W/ft)	EFFICACY (lm/W)	(CRI)	COLOR ACCURACY (R9)	(SDCM)
VERSION NF1-AA40	4000 K	468	4.69	99.8	83.7	12.1	< 2
	3500 K	462	4.69	98.4	83.7	12.1	
REPORT 11651177.01	3000 K	455	4.69	97.0	83.3	7.4	

B 6 W/ft	CCT	LIGHT (lm/ft)	ENERGY (W/ft)	EFFICACY (lm/W)	(CRI)	COLOR ACCURACY (R9)	(SDCM)
VERSION NF1-AB40	4000 K	604	5.92	102.0	82.9	6.7	< 2
	3500 K	596	5.92	100.6	82.9	6.7	
REPORT 11921916.02	3000 K	587	5.92	99.2	83.3	7.4	

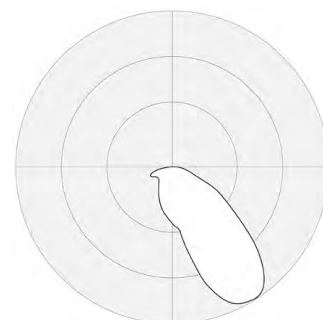

100% Dn Asymmetric
Notch 4
NT1-A

Integrating Sphere and Photometric results at 4000K by an independent accredited testing laboratory per IES LM-79-2008 and ANSI C78.377-2011. Results for 3000K and 3500K scaled based on integrating sphere results of NF1-B at 19W (A). Candlepower Distribution scaled per total lumens of Integrating Sphere results.

NF1-AA40

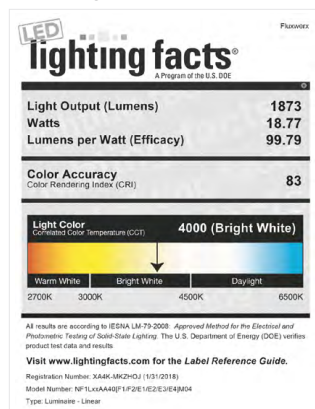

NF1-AB40

