

FLUXWERX®

SPECIFICATION DATA RAILS 2x4 (RA1-24)

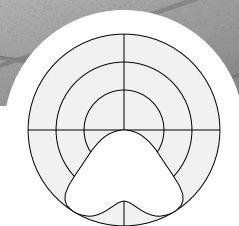
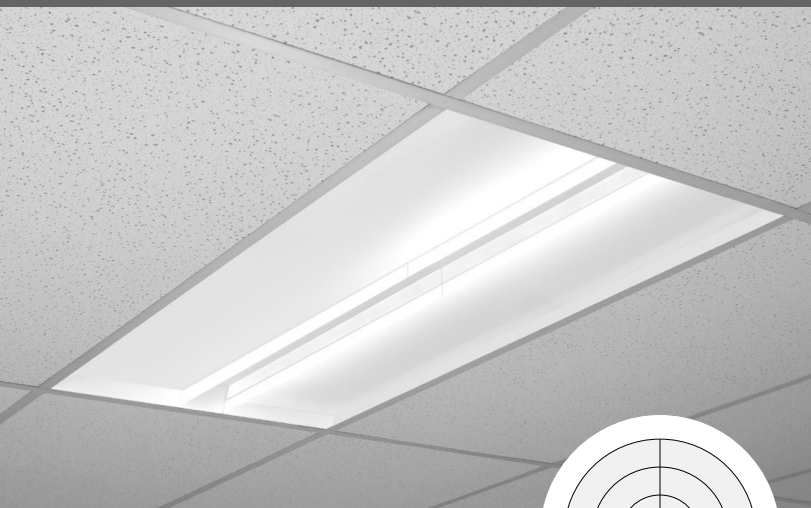

100% Dn

DIMENSIONS

CROSS SECTION

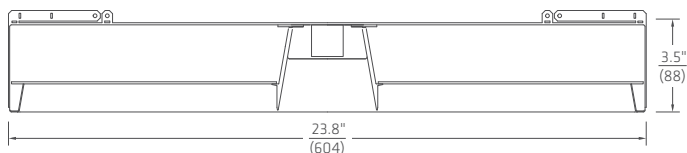

SIDE VIEW

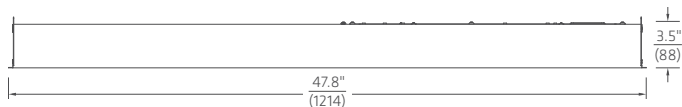

CATALOG

PROJECT

NOTES

PERFORMANCE SUMMARY

	A	B	C	D
Light (lm)	3000	3700	4550	5600
Energy (W)	22	28	36	46
Efficacy (lm/W)	134	132	130	126
Color Rendering (CRI)	80+			
Color Accuracy (SDCM)	< 2			
L70 Estimate (h)	200,000			150,000
Lumen Maintenance per TM21 (@ 54,000 h)	L90			L88

Summary values are nominal and based on 4000K CCT.

FEATURES

- Twin parallel optical rails redefine recessed with a balance of unexpected aesthetics and uncompromising performance.
- The dual lit rails, balanced with the luminous floating effect of translucent horizontal panels, eliminate visible images of intense LED point sources.
- Latest linear Anidolic optics deliver an optimized beam distribution for up to 10' x 12' spacing, delivering over 40 fc at less than 0.4 W/ft² and workplane max/min under 1.5.
- Priced for a wide range of real-world projects.
- Available in three sizes – 2x2, 1x4 & 2x4 – to suit a variety of applications and spaces.
- IC rated, CCEA approved, third party tested and backed by a 5-year warranty.



ORDER GUIDE

1	2	3	4	5	6	OPTIONS	CONTROLS
RA1	24						

1 FAMILY	2 SIZE	3 ENERGY ¹	4 CCT	5 DRIVER
RA1 Rails	22 2' x 2'	A 22 W B 28 W C 36 W	30 3000 K 35 3500 K 40 4000 K	F1 Non-Dim F2 0-10 V Dim 3% E1 eldoLED ECO 0-10 V Dim 1% E2 eldoLED SOLO 0-10 V Dim 0.1% E3 eldoLED ECO DALI Dim 1% E4 eldoLED SOLO DALI Dim 0.1% L1 Lutron Hi-Lume 1% EcoSystem (LDE1)
	14 1' x 4'	A 22 W B 28 W C 36 W D 46 W		
	▶24 2' x 4'			
		¹ Nominal input power. Add 4 W for 347 V with E1-4/L1.		

6 VOLTAGE	OPTIONS ³	CONTROLS
M 120-277 V 3 347 V ²	B Battery Pack C Chicago Plenum F 6' Flex Whip H Emergency Switching (GTD or Controller) K1 Drywall Flange Kit - Trim K2 Drywall Flange Kit - Trimless	RE1 Remote Enlighted Smart Sensor VN1 Acuity nLight Converter
² 347 V Driver for F1/F2, 347 V Transformer & Driver for E1-4/L1.	³ BP & GTD available for 120-277 V.	

PRODUCT DETAILS

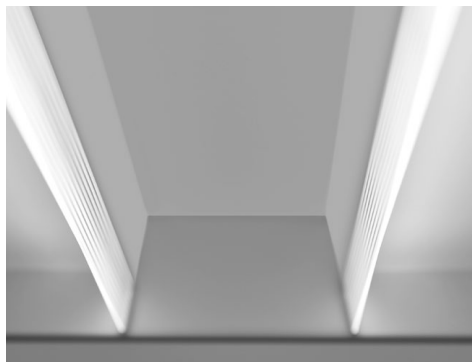

LINEAR ANIDOLIC OPTIC

CEILING INTEGRATION

FLAT GRID

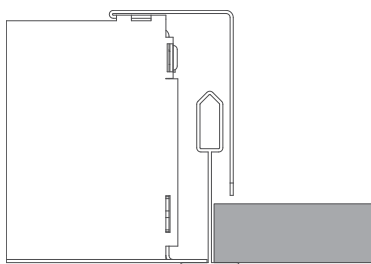

SLOT GRID

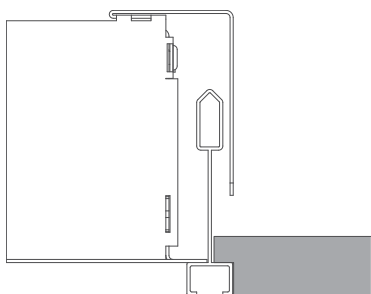

DRYWALL

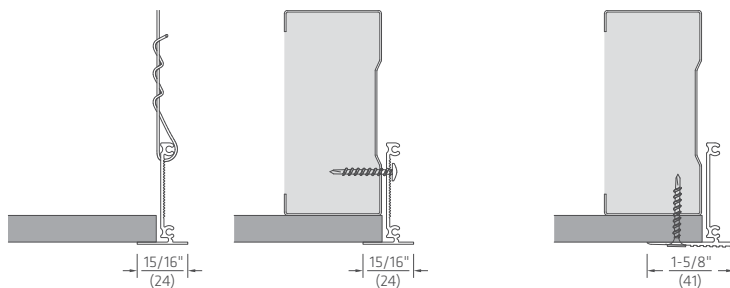

Trim Flange Kit

Trimless (mud-in) Flange Kit

DRYWALL FLANGE KIT

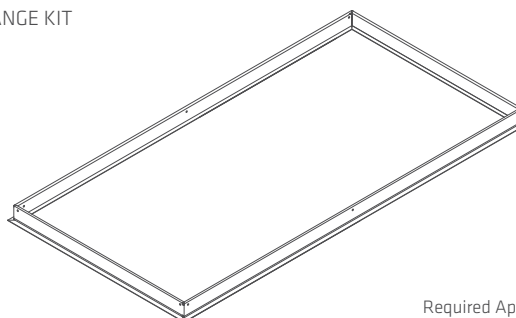

Required Aperture: $\frac{24.5"}{622} \times \frac{48.5"}{1232}$

SPECIFICATION DATA

RAILS 2x4 (RA1-24)

NOTES

CONSTRUCTION

- Formed 22 ga. steel housing
- Quick wire access plate and integral seismic restraint tabs/tie-offs
- Optional drywall trim or trimless (mud-in) flange kits
- High reflectance diffuse white textured powdercoat

OPTICAL

- Anidolic optical structures with linear light extraction elements
- Precision molded high transmittance clear acrylic lenses
- Long life LED system designed for typical TM21 lumen maintenance \geq L90 @ 54,000 h
- Available in CCTs 3000 K, 3500 K or 4000 K with CRI \geq 80 and R9 \geq 0, all with color accurate binning \leq 2 SDCM

ELECTRICAL

- Integral high efficiency drivers for 50–60 Hz, 120–277 V or 347 V
- Power Factor $>$ 0.90
- Total Harmonic Distortion $<$ 20%
- Dim level: Standard 3%, optional 1% or 0.1%
- Optional Battery Pack delivers 10 W Class 2 rated output for 90 min. Use 12 W input energy to estimate emergency flux, typically 1150–1750 lm (@100–150 lm/W).
- Optional GTD (Generator Transfer Switch), 120–277 V, disables 0–10 V control during emergency for full light output
- Optional flex whip: 6' prewired
- Surge Protection: Meets ANSI C82.11 spec and ANSI/IEEE C62.41
- Inrush Current: Meets NEMA 410

ENVIRONMENTAL & CARE

- Designed for use in dry or damp indoor locations with ambient temperatures of 0–30° C (32–86° F)
- Not suitable for natatorium environments, e.g. swimming pools, hot tubs and saunas. The luminaire may be damaged by chemicals such as chlorine, solvents, ammonia, alcohol or sulfur in the area of operation or in cleaning products. Damage from contaminants is not covered under warranty.
- Clean only by wiping with a slightly water-damp, soft, clean cloth.

WEIGHT

- Maximum 22.9 lbs (10.4 kg) with standard driver
- Maximum 27.7 lbs (12.6 kg) with battery pack or 347 V transformer

WARRANTY

- 5 year limited warranty on all components and workmanship

INDEPENDENT TESTING

- IESNA LM79
- IESNA LM80 (LED @ 9,000 or 10,000 h)

APPROVALS



- UL Listed (USA + Canada)
- CCEA Chicago Plenum
- IC Rated
- DesignLights Consortium®
Most options DLC qualified, please check catalog number in the QPL list (www.designlights.org/QPL)

CONTROLS & SENSORS



Fluxwerx products are designed for simple integration with a wide range of sensors, lighting controls and building management systems. Many projects incorporate occupancy sensing, daylight harvesting, individual or central adjustment of light levels and luminaire or space monitoring in order to save energy, reduce costs and maximize occupant comfort. Fluxwerx offers a number of standard driver and controller options to support various wired and wireless network protocols.

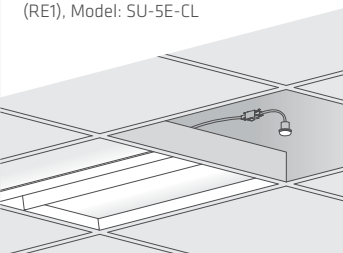

Enlighted wireless, networked smart sensor integrates occupancy sensing, daylight harvesting, energy usage, temperature and light level control. Option: Remote Enlighted sensor (RE1), Model: SU-5E-CL

nLight wired, 2-way network supports luminaire light level control as well as occupancy and daylight sensors. Option: Acuity nLight Converter (VN1), Model: nPS-80-EZ or nPS-80-EZ-ER

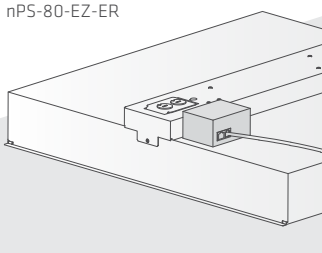
EldoLED drivers support common wired protocols, 0–10 V and DALI. They also provide access to finer dimming control, dynamic white and Bluetooth low-energy (BLE) wireless. Options: ECO 1% (E1), SOLO 0.1% (E2)



Lutron EcoSystem network protocol enables on/off, dimming, occupancy sensing and daylight harvesting. Option: Hi-Lume 1% EcoSystem (L1), Model: LDE1



SPECIFICATION DATA

RAILS 2x4 (RA1-24)

PERFORMANCE DATA

A 22 W	CCT	LIGHT (lm)	ENERGY (W)	EFFICACY (lm/W)	(CRI)	COLOR ACCURACY (R9)	(SDCM)
VERSION RA1-24A40	4000 K	2986	22.29	133.9	83.3	6.1	< 2
	3500 K	2862	22.15	128.3	83.3	6.1	
REPORT 13003414.17	3000 K	2737	22.15	123.6	83.6	9.2	
B 28 W	CCT	LIGHT (lm)	ENERGY (W)	EFFICACY (lm/W)	(CRI)	COLOR ACCURACY (R9)	(SDCM)
VERSION RA1-24B40	4000 K	3709	28.18	131.6	83.3	5.9	< 2
	3500 K	3570	28.32	126.7	83.3	5.9	
REPORT 13003414.19	3000 K	3431	28.32	121.1	83.3	7.7	
C 36 W	CCT	LIGHT (lm)	ENERGY (W)	EFFICACY (lm/W)	(CRI)	COLOR ACCURACY (R9)	(SDCM)
VERSION RA1-24C40	4000 K	4559	34.91	130.6	83.2	5.6	< 2
	3500 K	4398	34.91	126.0	83.2	5.6	
REPORT 13003414.21	3000 K	4237	34.91	121.4	83.3	7.7	
D 45 W	CCT	LIGHT (lm)	ENERGY (W)	EFFICACY (lm/W)	(CRI)	COLOR ACCURACY (R9)	(SDCM)
VERSION RA1-24D40	4000 K	5586	44.19	126.4	83.1	5.4	< 2
	3500 K	5389	44.7	121.9	83.1	5.4	
REPORT 13003414.23	3000 K	5191	44.7	116.1	83.3	7.7	

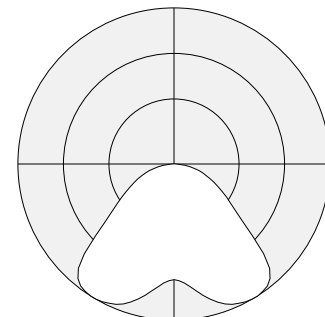

100% Dn
Rails
2' x 4'
4000 K

Integrating Sphere and Photometric results at 4000K from an independent accredited testing laboratory per IES LM-79-2008 and ANSI C78.377-2011. Results for 3000K and 3500K scaled based on integrating sphere results at 46W (D). Candlepower Distribution scaled per total lumens of Integrating Sphere results.