

FLUXWERX

SPECIFICATION DATA LOOP RECESSED 1x1 (LR1-11)

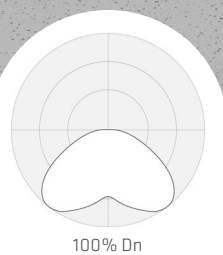

CROSS SECTION

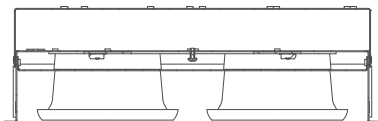

DIMENSIONS

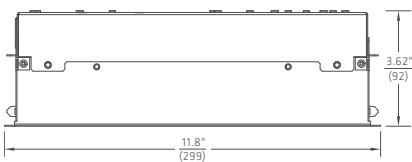

SIDE VIEW

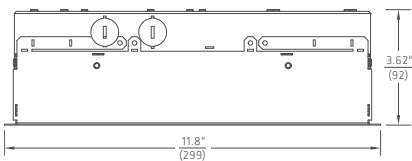

FRONT VIEW

CATALOG

PROJECT

NOTES

PERFORMANCE SUMMARY

	A	B	C
Light (lm)	1450	1800	2300
Energy (W)	12	15	19
Efficacy (lm/W)	130	128	122
Color Rendering (CRI)	80+		
Color Accuracy (SDCM)	< 2		
L70 Estimate (h)	200,000		150,000
Lumen Maintenance per TM21 (@ 54,000 h)	L90		L88

Summary values are nominal and based on 4000K CCT.

FEATURES

- Fluxwerx radial Anidolic optics provide a precisely controlled 360° symmetrical batwing distribution with no view of the LED point source
- Complete family of recessed configurations for a multitude of applications and spaces: 1x1, 1x2, 1x4, 2x2, 2x4 plus 6"x1, 6"x1.5, 6"x2 and 6"x4
- Companion Loop Suspended family allows for an aesthetically connected design language
- Suitable for T-Bar or Drywall ceilings with a Trim or Trimless Flange. 6" wide versions are compatible with TechZone™ and USGBX™ ceiling systems
- The light distribution and high efficacies combine to allow wide fixture spacing with ample general illumination at energy densities less than 0.4 W/ft²
- Third party tested, Lighting Facts certified and backed by a 5-year warranty



SPECIFICATION DATA
LOOP RECESSED 1x1 (LR1-11)

ORDER GUIDE

1	2	3	4	5	6	OPTIONS				
LR1	11									

1 FAMILY	2 SIZE	3 ENERGY ¹	4 CCT	5 DRIVER
LR1 Loop Recessed	61 6" x 1' (2 loop)	A 9.5 W	30 3000 K 35 3500 K 40 4000 K	F1 Non-Dim F2 0-10 V Dim 3% E1 eldoLED ECO 0-10 V Dim 1% E2 eldoLED SOLO 0-10 V Dim 0.1% E3 eldoLED ECO DALI 1% E4 eldoLED SOLO DALI Dim 0.1% L1 Lutron Hi-Lume 1%-H EcoSystem
	65 6" x 1.5' (3 loop)	A 12 W B 15 W		
	▶ 11 1' x 1'	A 12 W		
	62 6" x 2'	B 15 W		
	12 1' x 2'	C 19 W		
	22 2' x 2'	A 19 W		
	64 6" x 4'	B 23 W		
	14 1' x 4'	C 29 W		
	24 2' x 4'	D 38 W		

6 VOLTAGE	OPTIONS
M 120-277 V 3 347 V ²	B Battery Pack ³ C Chicago Plenum F 6' Flex Whip K2 Drywall Flange Kit - Trimless ⁴
² 347 V Driver for F1/F2, 347 V Transformer & Driver for E1-4/L1	³ Available for 120-277 V ⁴ Flange kit with trim supplied as standard

CEILING INTEGRATION GRID

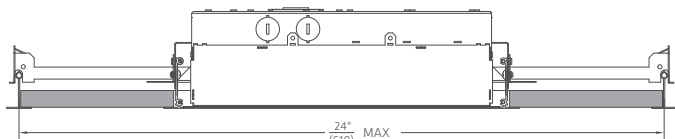

CEILING INTEGRATION DRYWALL

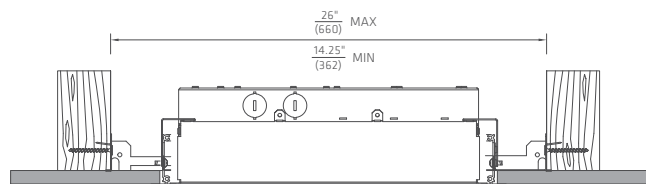

Trim or Trimless (mud-in) Flange Kit

CEILING INTEGRATION GRID

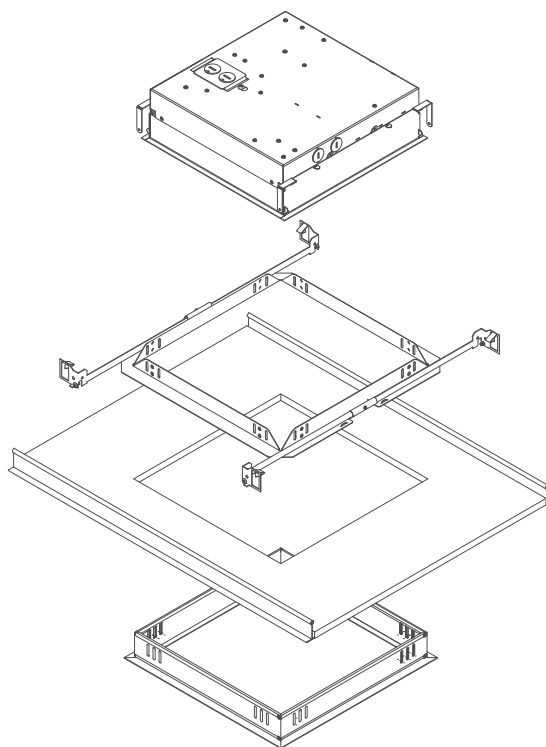
Required Aperture: 12.5" x 12.5"
(318 x 318)

CONSTRUCTION

- Formed 22 ga. steel housing
- Quick wire access plate and integral seismic restraint tabs/tie-offs
- Supplied drywall trim flange kit or optional trimless (mud-in) flange kit
- High reflectance diffuse white textured powdercoat

OPTICAL

- Radial Anidolic optical structures with detailed light extraction elements for 360° symmetric batwing distribution
- Precision molded high transmittance clear acrylic lenses
- Long life LED system designed for typical TM21 lumen maintenance \geq L90 @ 54,000 h
- Available in CCTs 3000 K, 3500 K or 4000 K with CRI \geq 80 and R9 \geq 0, all with color accurate binning \leq 2 SDCM

ELECTRICAL

- Integral high efficiency drivers 120-277 V or 347 V; 50-60 Hz
- Power Factor $>$ 0.90
- Total Harmonic Distortion $<$ 20%
- F2:0-10 V Dim Range: 3-100%
- Optional Battery Pack delivers 10 W Class 2 rated output for 90 min. Use 12 W input energy to estimate emergency flux, typically 1150-1750 lm (@100-150 lm/W).
- Optional Lutron: Hi-lume H-Series EcoSystem LED drivers for 100-1% (PWM) dim range
- Optional flex whip: 6' prewired
- Surge Protection: Meets ANSI C82.11 spec and ANSI/IEEE C62.41
- Inrush Current: Meets NEMA 410

ENVIRONMENTAL & CARE

- Designed for use in dry or damp indoor locations with ambient temperatures of 0-30° C (32-86° F)
- Not suitable for natatorium environments, e.g. swimming pools, hot tubs and saunas. The luminaire may be damaged by chemicals such as chlorine, solvents, ammonia, alcohol or sulfur in the area of operation or in cleaning products. Damage from contaminants is not covered under warranty.
- Clean only by wiping with a slightly water-damp, soft, clean cloth.

WEIGHT

- Maximum 9 lb (4.1 kg)
- Maximum 13 lb (5.9 kg) with battery pack

WARRANTY

- 5 year limited warranty on all components and workmanship

INDEPENDENT TESTING

- IESNA LM79
- IESNA LM80 (LED @ 9,000 h)

APPROVALS

- UL Listed (USA + Canada)
- CCEA Chicago Plenum
- IC Rated
- Lighting Facts®
- DesignLights Consortium®
Most options DLC qualified, please check catalog number in the QPL list (www.designlights.org/QPL)

SPECIFICATION DATA

LOOP RECESSED 1x1 (LR1-11)

PERFORMANCE DATA

A 12 W	CCT	LIGHT (lm)	ENERGY (W)	EFFICACY (lm/W)	(CRI)	COLOR ACCURACY (R9)	(SDCM)
VERSION LR1-11A40	4000 K	1452	11.19	129.7	83	6.3	< 2
	3500 K	1434	11.19	128.1	83	6.3	
REPORT 12156787.12A	3000 K	1415	11.18	126.6	82.1	2.6	

B 15 W	CCT	LIGHT (lm)	ENERGY (W)	EFFICACY (lm/W)	(CRI)	COLOR ACCURACY (R9)	(SDCM)
VERSION LR1-11B40	4000 K	1814	14.19	127.8	82.9	6.2	< 2
	3500 K	1797	14.19	126.6	82.9	6.2	
REPORT 12156787.13A	3000 K	1780	14.19	125.4	81.8	1.6	

C 19 W	CCT	LIGHT (lm)	ENERGY (W)	EFFICACY (lm/W)	(CRI)	COLOR ACCURACY (R9)	(SDCM)
VERSION LR1-11C40	4000 K	2323	19	122.3	82.9	5.8	< 2
	3500 K	2301	19	121.1	82.9	5.8	
REPORT 12156787.01A	3000 K	2279	19.19	118.7	81.8	1.6	

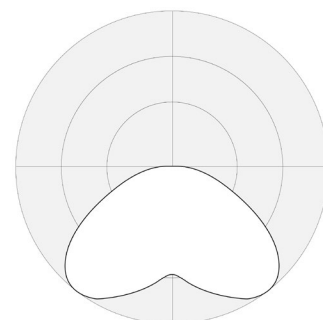

100% Dn
Loop Recessed
1' x 1'
4000 K

Integrating Sphere and Photometric results at 4000K by an independent accredited testing laboratory per IES LM-79-2008 and ANSI C78.377-2011. Results for 3000K, 3500K scaled based on integrating sphere results at 19W (C). Candlepower Distribution scaled per total lumens of Integrating Sphere results.

LR1-11A40

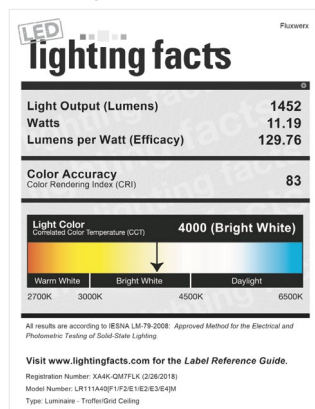

LR1-11B40

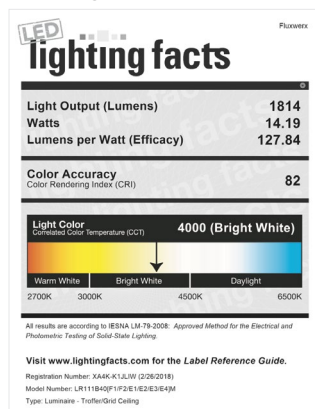

LR1-11C40

