



INBOX 2 X 2 NB2-22

Specification Data



CROSS SECTION

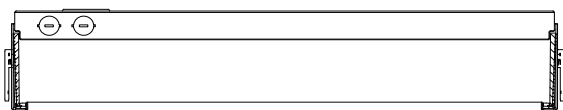

DIMENSIONS inches (mm)

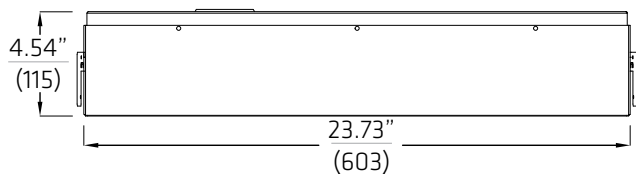

FRONT VIEW

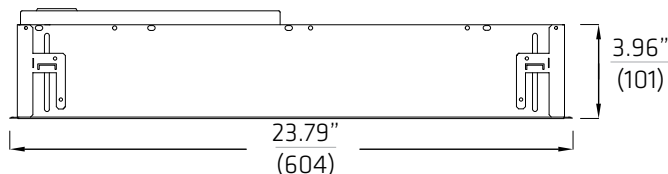

SIDE VIEW

Luminaire	INBOX 2 X 2 2-Sided Optics (NB2-22)	Type
Project		
Product		
Notes		



Performance Summary	Inbox 2 x 2 2 - Sided		
	A	B	C
Light (lm)	2500	3100	4000
Energy (W)	23	29	38
Efficacy (lm/W)	110	108	104
Color Rendering (CRI)	80+	80+	80+
Color Accuracy (SDCM)	< 2	< 2	< 2
L70 Estimate (h)	200,000	200,000	200,000
Lumen Maintenance per TM21 (@ 60,000 h)	L90	L90	L90

DLC qualified for each lumen output (A, B, C) in 3000K, 3500K & 4000K. Summary values are nominal and based on 4000K CCT.

SPECIFICATION

NB2	22						OPTIONS
1	2	3	4	5	6		
1. FAMILY	2. SIZE	3. ENERGY ¹	4. CCT	5. DRIVER	6. VOLTAGE	OPTIONS	
NB2 Inbox	12 1 x 2 (2-sided optics) 14 1 x 4 (2-sided optics) 22 2 x 2 (2-sided optics) 24 2 x 4 (2-sided optics)	A 23 W B 29 W C 38 W D 47 W ²	30 3000 K 35 3500 K 40 4000 K	E1 eldoLED ECO 0-10V Dim 1% E2 eldoLED SOLO 0-10V Dim 0.1% E3 eldoLED ECO DALI 1% E4 eldoLED SOLO DALI Dim 0.1% F1 Factory Non- Dim F2 Factory 0-10V Dim 3% L1 Lutron Hi-Lume 1%-H EcoSystem	M 120 - 277 V 3 347 V ³	B Battery Pack ⁴ C Chicago Plenum F 6' Flex Whip K Drywall Flange Kit	
NB1 Inbox	22 2 x 2 (4-sided optics)						

NOTES			
¹ Add 4W to above for 347V with E1-4/L1	² 1 x 4 2 x 4 2 x 2 (4 sided) only	³ 347 V Driver for F1/F2 347 V Transformer & Driver E1-4/L1	⁴ Available for 120-277V

CEILING INTEGRATION GRID

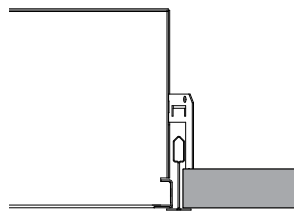

FLAT GRID

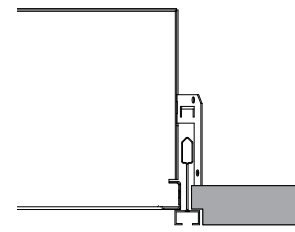

SLOT GRID

CEILING INTEGRATION DRYWALL

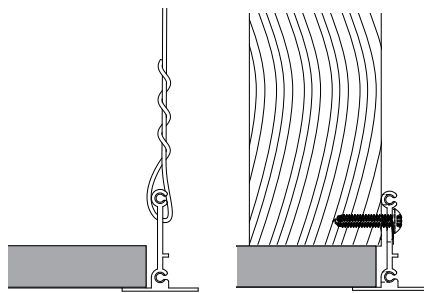

DRYWALL FLANGE KIT

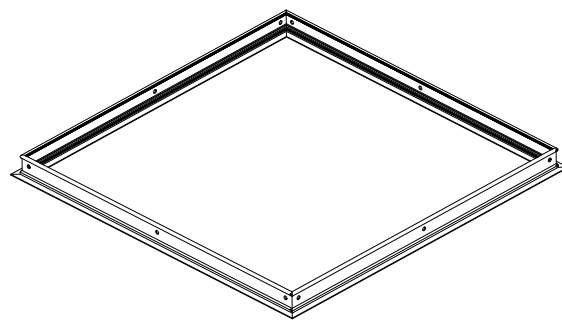

Required Aperture: 24.63" x 24.63" (625 x 625)

CONSTRUCTION

- Die formed 22 ga. steel housing
- Quick wire access plate and integral seismic restraint tabs/tie-offs
- Option for (K) drywall flange kit
- High reflectance diffuse white textured powdercoat

OPTICAL

- Anidolic optical structures with linear light extraction elements
- Precision extruded high transmittance clear acrylic lenses
- Long life LED system designed for typical TM21 lumen maintenance \geq L90 @ 60,000 h
- Available in CCTs 3000 K, 3500 K or 4000 K with CRI \geq 80 and R9 \geq 0, all with color accurate binning \leq 2 SDCM

ELECTRICAL

- Integral high efficiency drivers 120 - 277 V or 347 V; 50 - 60 Hz
- Power Factor $>$ 0.90
- Total Harmonic Distortion $<$ 20%
- F2:0 - 10 V Dim Range: 3 - 100%
- Optional Battery Pack
- Optional Lutron: Hi-lume H-Series EcoSystem LED drivers for 100 - 1% (PWM) dim range
- Optional flex whip: 6' prewired
- Surge Protection: Meets ANSI C82.11 spec and ANSI/IEEE C62.41
- Inrush Current: Meets NEMA 410

WEIGHT

- Maximum 15 lb (6.5 kg)
- Maximum 19 lb (8.6 kg) with battery pack

WARRANTY

- 5 year limited warranty on all components and workmanship

ENVIRONMENTAL

- Designed for use in damp or dry indoor environments with room side operating temperatures of 0 - 30° C (32 - 86° F)

INDEPENDENT TESTING

- IESNA LM79
- IESNA LM80 (LED@ 10,000 h)

APPROVALS

- UL Listed (USA + Canada)
- CCEA Chicago Plenum
- DesignLights Consortium[®]
- Lighting Facts[®]
- IC Rated

Product	Inbox 2x2 2-sided	Description	Performance Summary					Light (lm)	Energy (W)	Efficacy (lm/W)	Color Accuracy		
Version	NB2-22A40	2x2 - 2 sided LED A Lumens CCT 4000 K	CCT Color Temperature	4000 K	2541	23	110.3	83.3	10.5	< 2			
Report	11660485.15			3500 K	2499	23	108	82	5	< 2			
				3000 K	2456	23	107	82	5	< 2			

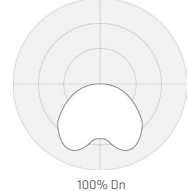

CANDLEPOWER DISTRIBUTION

Vertical Angle	Horizontal Angle				Zonal Lumens
	0°	22.5°	45°	67.5°	
0°	547	547	547	547	547
5°	544	547	547	546	545
15°	527	534	639	701	723
25°	495	585	723	790	811
35°	448	596	734	788	798
45°	386	562	683	698	699
55°	313	497	562	557	543
65°	229	396	417	356	343
75°	141	258	222	176	159
85°	45	69	49	44	44
90°	0	1	1	1	1

LUMEN SUMMARY

Zone	Lumens	% Lamp	% Fixture	
0-30°	547	N.A.	22	
0-60°	1885	N.A.	74	
0-90°	2541	N.A.	100	
90-180°	0	N.A.	0	
Total Luminaire	0-180°	2541	N.A.	100

LUMINANCE DATA (CD/M²)

Vertical Angle	0°	45°	90°
45°	1646	2872	2943
55°	1653	2950	2801
65°	1669	2914	2468
75°	1730	2618	2572
85°	1668	2233	1724

CO-EFFICIENTS OF UTILIZATION

Floor Ceiling Wall	80				70				20				30				10				0				
	70	50	30	10	70	50	30	10	50	30	10	50	30	10	50	30	10	50	30	10	50	30	10	50	30
0	119	119	119	119	116	116	116	111	111	106	106	102	102	100											
1	108	102	98	93	105	100	92	96	89	92	86	88	84	81											
2	97	88	81	74	94	86	73	82	72	79	70	76	68	66											
3	88	76	68	61	85	75	60	72	59	69	58	66	57	54											
4	80	67	58	50	77	66	50	63	49	61	49	58	48	46											
5	73	59	50	43	71	58	42	56	42	54	41	52	41	39											
6	67	53	43	37	65	52	37	50	36	48	36	47	35	33											
7	62	48	38	32	60	47	32	45	32	44	31	42	31	29											
8	57	43	34	28	56	42	28	41	28	40	28	39	27	25											
9	53	39	31	25	52	39	25	38	25	37	25	35	24	23											
10	50	36	28	22	49	36	22	35	22	34	22	33	22	20											

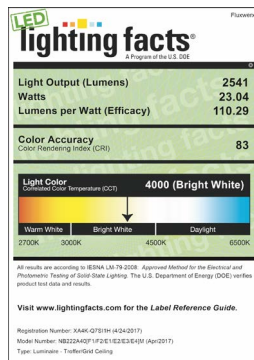

Integrating Sphere and Photometric results at 4000K by an independent accredited testing laboratory per IES LM-79-2008 and ANSI C78.377-2011. Results for 3000K, 3500K scaled based on integrating sphere results at 47W (D) and 2x2-4sided integrated sphere results for lumen outputs A, B & C. Candlepower Distribution scaled per total lumens of Integrating Sphere results.

Product	Inbox 2x2 2-sided	Description	Performance Summary					Light (lm)	Energy (W)	Efficacy (lm/W)	Color Accuracy		
Version	NB2-22B40	2x2 - 2 sided LED B Lumens CCT 4000 K	CCT Color Temperature	4000 K	3098	28.8	107.6	83.3	10.4	< 2			
Report	11660485.16			3500 K	3013	29	105	82	5	< 2			
				3000 K	2928	29	102	82	5	< 2			

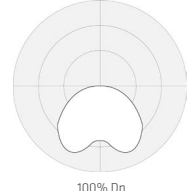

CANDLEPOWER DISTRIBUTION

Vertical Angle	Horizontal Angle				Zonal Lumens
	0°	22.5°	45°	67.5°	
0°	653	653	653	653	653
5°	649	650	654	656	660
15°	629	662	784	860	886
25°	592	715	881	953	974
35°	539	728	876	927	944
45°	467	684	814	828	834
55°	380	598	678	662	644
65°	283	480	494	426	418
75°	180	311	272	257	267
85°	58	86	78	65	60
90°	1	1	2	1	2

LUMEN SUMMARY

Zone	Lumens	% Lamp	% Fixture	
0-30°	667	N.A.	22	
0-60°	2298	N.A.	74	
0-90°	3098	N.A.	100	
90-180°	0	N.A.	0	
Total Luminaire	0-180°	3098	N.A.	100

LUMINANCE DATA (CD/M²)

Vertical Angle	0°	45°	90°
45°	2007	3501	3588
55°	2016	3596	3415
65°	2034	3553	3009
75°	2109	3191	3135
85°	2034	2722	2101

CO-EFFICIENTS OF UTILIZATION

Floor Ceiling Wall	80				70				20				30				10				0				
	70	50	30	10	70	50	30	10	50	30	10	50	30	10	50	30	10	50	30	10	50	30	10	50	30
0	119	119	119	119	116	116	116	111	111	106	106	102	102	100											
1	108	102	98	93	105	100	92	96	89	92	86	88	84	81											
2	97	88	81	74	94	86	73	82	72	79	70	76	68	66											
3	88	76	68	61	85	75	60	72	59	69	58	66	57	54											
4	80	67	58	50	77	66	50	63	49	61	49	58	48	46											
5	73	59	50	43	71	58	42	56	42	54	41	52	41	39											
6	67	53	43	37	65	52	37	50	36	48	36	47	35	33											
7	62	48	38	32	60	47	32	45	32	44	31	42	31	29											
8	57	43	34	28	56	42	28	41	28	40	28	39	27	25											
9	53	39	31	25	52	39	25	38	25	37	25	35	24	23											
10	50	36	28	22	49	36	22	35	22	34	22	33	22	20											

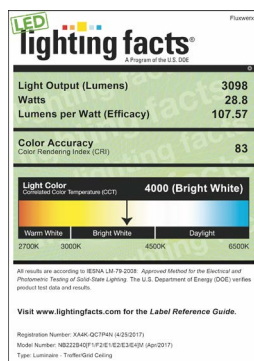

Product	Inbox 2x2 2-sided	Description	Performance Summary					Light (lm)	Energy (W)	Efficacy (lm/W)	Color Accuracy		
Version	NB2-22C40	2x2 - 2 sided LED C Lumens CCT 4000 K	CCT Color Temperature	4000 K	3997	38.3	104.4	83.3	10.1	< 2			
Report	11660485.18			3500 K	3888	38.5	101	82	5	< 2			
				3000 K	3778	38	99.5	82	3.7	< 2			

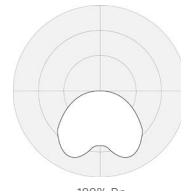

100% Dn

CANDLEPOWER DISTRIBUTION

Vertical Angle	Horizontal Angle				Zonal Lumens
	0°	22.5°	45°	67.5°	
0°	843	843	843	843	843
5°	837	839	844	846	851
15°	812	854	1011	1110	1143
25°	764	923	1137	1230	1257
35°	695	940	1130	1196	1218
45°	602	883	1050	1068	1076
55°	491	771	875	854	831
65°	365	619	637	549	540
75°	232	401	350	331	344
85°	75	110	101	84	78
90°	1	1	2	2	2
95°					
105°					
115°					
125°					
135°					
145°					
155°					
165°					
175°					
180°					

LUMEN SUMMARY

Zone	Lumens	% Lamp	% Fixture
0-30°	860	N.A.	22
0-60°	2965	N.A.	74
0-90°	3997	N.A.	100
90-180°	0	N.A.	0
Total Luminaire	0-180°	3997	100

LUMINANCE DATA (CD/M²)

Vertical Angle	Horizontal Angle		
	0°	45°	90°
45°	2589	4518	4629
55°	2601	4640	4406
65°	2624	4585	3883
75°	2721	4117	4046
85°	2624	3514	2708

CO-EFFICIENTS OF UTILIZATION

Floor Ceiling Wall	80				70				20			
	70	50	30	10	70	50	30	10	50	10	50	10
0	119	119	119	119	116	116	116	111	111	106	106	102
1	108	102	98	93	105	100	92	96	89	92	86	88
2	97	88	81	74	94	86	73	82	72	79	70	76
3	88	76	68	61	85	75	60	72	59	69	58	66
4	80	67	58	50	77	66	50	63	49	61	49	58
5	73	59	50	43	71	58	42	56	42	54	41	52
6	67	53	43	37	65	52	37	50	36	48	36	47
7	62	48	38	32	60	47	32	45	32	44	31	42
8	57	43	34	28	56	42	28	41	28	40	28	39
9	53	39	31	25	52	39	25	38	25	37	25	35
10	50	36	28	22	49	36	22	35	22	34	22	33

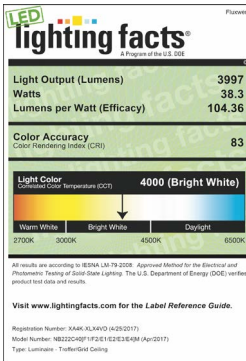

Integrating Sphere and Photometric results at 4000K by an independent accredited testing laboratory per IES LM-79-2008 and ANSI C78.377-2011. Results for 3000K, 3500K scaled based on integrating sphere results at 47W (D) and 2x2-4sided integrated sphere results for lumen outputs A, B & C. Candlepower Distribution scaled per total lumens of Integrating Sphere results.