



INBOX 1 X 2 NB2-12

Specification Data



Luminaire	INBOX 1 X 2 (NB2-12)	Type
Project		
Product		
Notes		



CROSS SECTION

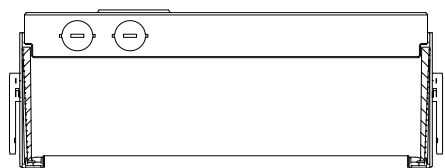

Performance Summary	Inbox 1 x 2		
	A	B	C
Light (lm)	2550	2950	3800
Energy (W)	23	29	38
Efficacy (lm/W)	111	102	101
Color Rendering (CRI)	80+	80+	80+
Color Accuracy (SDCM)	< 2	< 2	< 2
L70 Estimate (h)	200,000	200,000	200,000
Lumen Maintenance per TM21 (@ 60,000 h)	L90	L90	L90

DLC qualified for each lumen output (A, B, C) in 3000K, 3500K & 4000K. Summary values are nominal and based on 4000K CCT.

DIMENSIONS

inches
(mm)

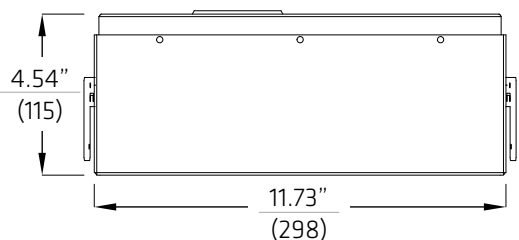

FRONT VIEW

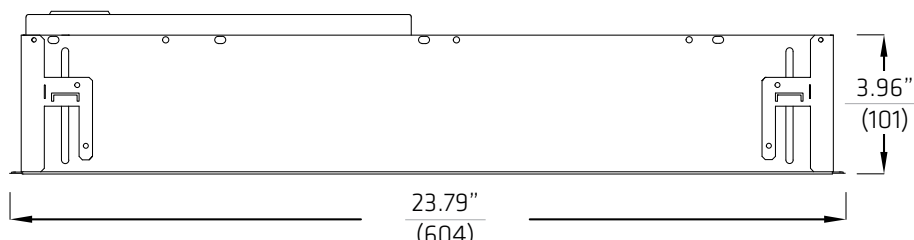

SIDE VIEW

SPECIFICATION

NB2		12								OPTIONS	
1	2	3	4	5	6						
1. FAMILY	2. SIZE	3. ENERGY ¹	4. CCT	5. DRIVER	6. VOLTAGE	OPTIONS					
NB2 Inbox	12 1 x 2 (2-sided optics)	A 23 W	30 3000 K	E1 eldoLED ECO 0-10V Dim 1%	M 120 - 277 V 3 347 V ³	B Battery Pack ⁴ C Chicago Plenum F 6' Flex Whip K Drywall Flange Kit					
	14 1 x 4 (2-sided optics)	B 29 W	35 3500 K	E2 eldoLED SOLO 0-10V Dim 0.1%							
	22 2 x 2 (2-sided optics)	C 38 W	40 4000 K	E3 eldoLED ECO DALI 1%							
	24 2 x 4 (2-sided optics)	D 47 W ²		E4 eldoLED SOLO DALI Dim 0.1%							
NB1 Inbox	22 2 x 2 (4-sided optics)			F1 Factory Non-Dim							
				F2 Factory 0-10V Dim 3%							
				L1 Lutron Hi-Lume 1%-H EcoSystem							

NOTES

¹ Add 4W to above for 347V with E1-4/L1

² 1 x 4 | 2 x 4 | 2 x 2 (4 sided) only

³ 347 V Driver for F1/F2 347 V Transformer & Driver E1-4/L1

⁴ Available for 120-277V

CEILING INTEGRATION GRID

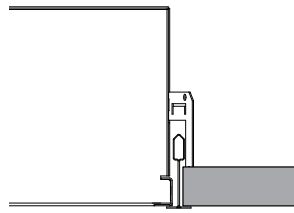

FLAT GRID

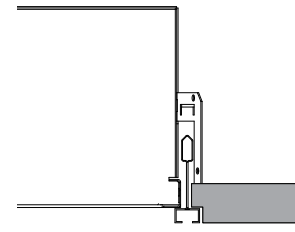

SLOT GRID

CEILING INTEGRATION DRYWALL

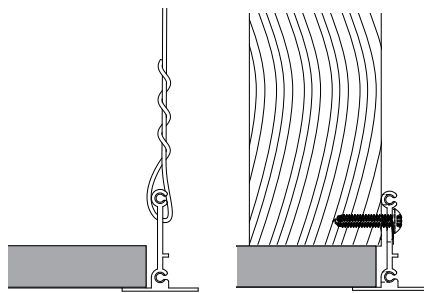

DRYWALL FLANGE KIT

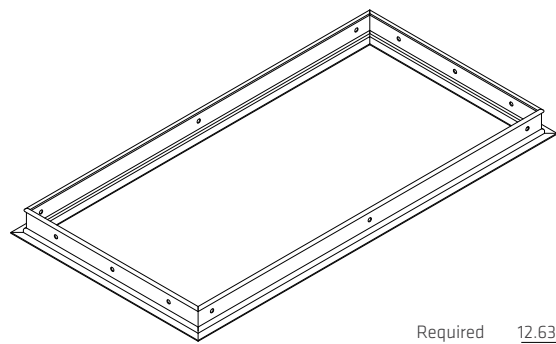

Required 12.63" x 24.63"
Aperture: (321 x 625)

CONSTRUCTION

- Die formed 22 ga. steel housing
- Quick wire access plate and integral seismic restraint tabs/tie-offs
- Option for (K) drywall flange kit
- High reflectance diffuse white textured powdercoat

OPTICAL

- Anidolic optical structures with linear light extraction elements
- Precision extruded high transmittance clear acrylic lenses
- Long life LED system designed for typical TM21 lumen maintenance \geq L90 @ 60,000 h
- Available in CCTs 3000 K, 3500 K or 4000 K with CRI \geq 80 and R9 \geq 0, all with color accurate binning \leq 2 SDCM and Dynamic White in 2700-6500K.

ELECTRICAL

- Integral high efficiency drivers 120 - 277 V or 347 V; 50 - 60 Hz
- Power Factor $>$ 0.90
- Total Harmonic Distortion $<$ 20%
- F2:0 - 10 V Dim Range: 3 - 100%
- Optional Battery Pack
- Optional Lutron: Hi-lume H-Series EcoSystem LED drivers for 100 - 1% (PWM) dim range
- Optional flex whip: 6' prewired
- Surge Protection: Meets ANSI C82.11 spec and ANSI/IEEE C62.41
- Inrush Current: Meets NEMA 410

WEIGHT

- Maximum 11 lb (4.8 kg)
- Maximum 15 lb (6.8 kg) with battery pack

WARRANTY

- 5 year limited warranty on all components and workmanship

ENVIRONMENTAL

- Designed for use in damp or dry indoor environments with room side operating temperatures of 0 - 30° C (32 - 86° F)

INDEPENDENT TESTING

- IESNA LM79
- IESNA LM80 (LED@ 10,000 h)

APPROVALS

- UL Listed (USA + Canada)
- CCEA Chicago Plenum
- DesignLights Consortium®
- Lighting Facts®
- IC Rated

Product	Inbox 1x2	Description	Performance Summary		Light (lm)	Energy (W)	Efficacy (lm/W)	Color Accuracy		
Version	NB2-12A40	1x2 LED A Lumens CCT 4000 K	CCT Color Temperature	4000 K	2548	23.0	110.6	83	10	< 2
Report	FLUXWERX			3500 K	2505	23	109	82	5	< 2
				3000 K	2463	23.6	104	82	5	< 2

100% Dn

Vertical Angle	Horizontal Angle				Zonal Lumens
	0°	22.5°	45°	67.5°	
0°	547	547	547	547	547
5°	544	547	547	546	545
15°	527	534	639	701	723
25°	495	585	723	790	811
35°	448	596	734	788	798
45°	386	562	683	698	699
55°	313	497	562	557	543
65°	229	396	417	356	343
75°	141	258	222	176	159
85°	45	69	49	44	44
90°	0	1	1	1	1
95°					
105°					
115°					
125°					
135°					
145°					
155°					
165°					
175°					
180°					

Zone	Lumens	% Lamp	% Fixture
0-30°	549	N.A.	22
0-60°	1913	N.A.	75
0-90°	2548	N.A.	100
90-180°	0	N.A.	0
Total Luminaire	2548	N.A.	100

Vertical Angle	0°	45°	90°
	45°	3541	6268
55°	3538	6353	6143
65°	3520	6399	5265
75°	3521	5560	3977
85°	3356	3668	3252

Floor Ceiling Wall	80				70				20				
	70	50	30	10	70	50	10	50	10	50	10	50	10
0	119	119	119	119	116	116	116	111	111	106	106	102	102
1	108	103	98	94	105	100	92	96	89	92	87	89	84
2	97	88	81	75	95	87	74	83	72	80	71	76	69
3	88	77	68	61	85	75	61	72	59	69	58	67	57
4	80	67	58	51	78	66	50	63	50	61	49	59	48
5	73	60	50	43	71	58	43	56	42	54	42	52	41
6	67	53	44	37	65	52	37	50	36	49	36	47	36
7	62	48	39	32	60	47	32	45	32	44	32	43	31
8	58	43	34	28	56	43	28	41	28	40	28	39	28
9	54	40	31	25	52	39	25	38	25	37	25	36	25
10	50	36	28	23	49	36	22	35	22	34	22	33	22

Integrating Sphere and Photometric results at 4000K , 38W (C) by an independent accredited testing laboratory per IES LM-79-2008 and ANSI C78.377-2011. Results for 3000K, 3500K scaled based on integrating sphere results at 38W (C) and 2x2-4sided integrated sphere results for Lumen outputs A, B, C. Candlepower Distribution scaled per total lumens of Integrating Sphere results.

Product	Inbox 1x2	Description	Performance Summary		Light (lm)	Energy (W)	Efficacy (lm/W)	Color Accuracy		
Version	NB2-12B40	1x2 LED B Lumens CCT 4000 K	CCT Color Temperature	4000 K	2940	28.8	102.1	83	10	< 2
Report	FLUXWERX			3500 K	2891	28.9	100	82	5	< 2
				3000 K	2842	28.7	99	82	4.1	< 2

100% Dn

Vertical Angle	Horizontal Angle				Zonal Lumens
	0°	22.5°	45°	67.5°	
0°	631	631	631	631	631
5°	628	632	631	630	629
15°	608	616	737	809	834
25°	571	675	834	911	936
35°	517	688	847	909	921
45°	446	649	789	805	807
55°	361	573	648	643	627
65°	265	457	481	411	396
75°	162	297	256	203	183
85°	52	80	57	51	51
90°	1	1	1	1	1
95°					
105°					
115°					
125°					
135°					
145°					
155°					
165°					
175°					
180°					

Zone	Lumens	% Lamp	% Fixture
0-30°	633	N.A.	22
0-60°	2208	N.A.	75
0-90°	2940	N.A.	100
90-180°	0	N.A.	0
Total Luminaire	2940	N.A.	100

Vertical Angle	0°	45°	90°
	45°	4087	7233
55°	4083	7331	7088
65°	4062	7384	6077
75°	4062	6417	4588
85°	3877	4226	3758

Floor Ceiling Wall	80				70				20				
	70	50	30	10	70	50	10	50	10	50	10	50	10
0	119	119	119	119	116	116	116	111	111	106	106	102	102
1	108	103	98	94	105	100	92	96	89	92	87	89	84
2	97	88	81	75	95	87	74	83	72	80	71	76	69
3	88	77	68	61	85	75	61	72	59	69	58	67	57
4	80	67	58	51	78	66	50	63	50	61	49	59	48
5	73	60	50	43	71	58	43	56	42	54	42	52	41
6	67	53	44	37	65	52	37	50	36	49	36	47	36
7	62	48	39	32	60	47	32	45	32	44	32	43	31
8	58	43	34	28	56	43	28	41	28	40	28	39	28
9	54	40	31	25	52	39	25	38	25	37	25	36	25
10	50	36	28	23	49	36	22	35	22	34	22	33	22

Product	Inbox 1x2	Description	Performance Summary					Light (lm)	Energy (W)	Efficacy (lm/W)	Color Accuracy		
Version	NB2-12C40	1x2 LED C Lumens CCT 4000 K	CCT Color Temperature	4000 K	3793	37.68	100.7	83.3	10.3	< 2			
Report	11660485.10			3500 K	3730	37.6	99	82	5	< 2			
				3000 K	3667	37.6	98	82	4.1	< 2			

100% Dn

CANDLEPOWER DISTRIBUTION

Vertical Angle	Horizontal Angle					Zonal Lumens
	0°	22.5°	45°	67.5°	90°	
0°	814	814	814	814	814	
5°	810	815	814	813	812	79
15°	785	795	951	1044	1076	266
25°	737	871	1076	1176	1207	472
35°	667	888	1093	1173	1188	638
45°	575	837	1018	1039	1041	714
55°	466	740	837	830	809	680
65°	342	589	621	530	511	537
75°	209	383	330	261	236	320
85°	67	103	73	66	65	88
90°	1	1	1	1	1	
95°	0	0	0	0	0	0
105°	0	0	0	0	0	0
115°	0	0	0	0	0	0
125°	0	0	0	0	0	0
135°	0	0	0	0	0	0
145°	0	0	0	0	0	0
155°	0	0	0	0	0	0
165°	0	0	0	0	0	0
175°	0	0	0	0	0	0
180°	0	0	0	0	0	0

LUMEN SUMMARY

Zone	Lumens	% Lamp	% Fixture
0-30°	817	N.A.	22
0-60°	2848	N.A.	75
0-90°	3793	N.A.	100
90-180°	0	N.A.	0
Total Luminaire	0-180°	3793	N.A.

LUMINANCE DATA (CD/M²)

Vertical Angle	Horizontal Angle		
	0°	45°	90°
45°	5273	9332	9546
55°	5267	9458	9145
65°	5242	9526	7840
75°	5242	8279	5921
85°	5000	5454	4844

CO-EFFICIENTS OF UTILIZATION

Floor Ceiling Wall	80				70				20				30				10				0			
	70	50	30	10	70	50	30	10	50	10	50	10	50	10	50	10	50	10	50	10	50	10		
0	119	119	119	119	116	116	116	111	111	106	106	102	102	100										
1	108	103	98	94	105	100	92	96	89	92	87	89	84	82										
2	97	88	81	75	95	87	74	83	72	80	71	76	69	67										
3	88	77	68	61	85	75	61	72	59	69	58	67	57	55										
4	80	67	58	51	78	66	50	63	50	61	49	59	48	46										
5	73	60	50	43	71	58	43	56	42	54	42	52	41	39										
6	67	53	44	37	65	52	37	50	36	49	36	47	36	34										
7	62	48	39	32	60	47	32	45	32	44	32	43	31	29										
8	58	43	34	28	56	43	28	41	28	40	28	39	28	26										
9	54	40	31	25	52	39	25	38	25	37	25	36	25	23										
10	50	36	28	23	49	36	22	35	22	34	22	33	22	20										

Integrating Sphere and Photometric results at 4000K , 38W (C) by an independent accredited testing laboratory per IES LM-79-2008 and ANSI C78.377-2011. Results for 3000K, 3500K scaled based on integrating sphere results at 38W (C) and 2x2-4sided integrated sphere results for Lumen outputs A, B, C. Candlepower Distribution scaled per total lumens of Integrating Sphere results.