



TRANSOM 2 x 2 TR1-22

Specification Data



CROSS SECTION

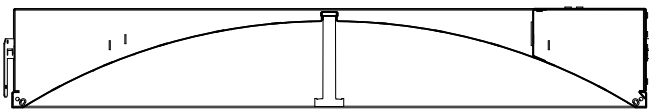

DIMENSIONS inches (mm)

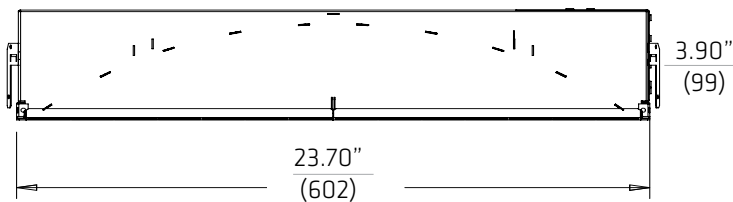

FRONT VIEW

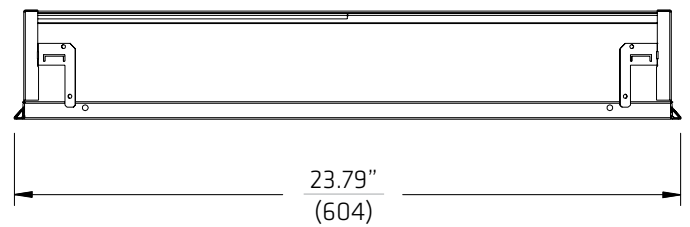

SIDE VIEW

SPECIFICATION

TR1	22																			
1	2	3	4	5	6	OPTIONS														
1. FAMILY	2. SIZE	3. ENERGY ²	4. CCT	5. DRIVER	6. VOLTAGE	OPTIONS														

TR1 Transom	14 1 x 4 22 2 x 2 24 2 x 4 52 20 x 24 54 20 x 48 ¹	A 23 W B 29 W C 38 W D 47 W ³	30 3000 K 35 3500 K 40 4000 K	E1 eldoLED ECO 0-10V Dim 1% E2 eldoLED SOLO 0-10V Dim 0.1% E3 eldoLED ECO DALI 1% E4 eldoLED SOLO DALI Dim 0.1% F1 Factory Non- Dim F2 Factory 0-10V Dim 3% L1 Lutron Hi-Lume 1%-H EcoSystem	M 120 - 277 V 3 347 V ⁴	B Battery Pack ⁵ C Chicago Plenum F 6' Flex Whip K Drywall Flange Kit
--------------------	--	---	--	---	---	---

NOTES					
¹ Optional filler panels available for 20 x 60	² Add 4W to above for 347 V with E1-4/L1	³ 1 x 4 2 x 4 20 x 48 only	⁴ 347 V Driver for F1/F2 347 V Transformer & Driver E1-4/L1	⁵ Available for 120-277V	

Luminaire	TRANSOM - 2 X 2 (TR1-22)	Type	
Project			
Product			
Notes			



Performance Summary	Transom 2 x 2		
	A	B	C
Light (lm)	2650	3200	4050
Energy (W)	23	29	38
Efficacy (lm/W)	113	110	104
Color Rendering (CRI)	80+	80+	80+
Color Accuracy (SDCM)	< 2	< 2	< 2
L70 Estimate (h)	200,000	200,000	200,000
Lumen Maintenance per TM21 (@ 60,000 h)	L90	L90	L90

DLC qualified for each lumen output (A,B,C) in 3000K, 3500K & 4000K. Summary values are nominal and based on 4000K CCT

CEILING INTEGRATION GRID

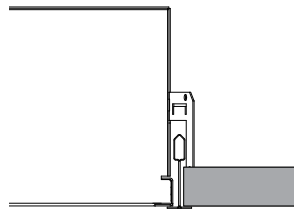

FLAT GRID

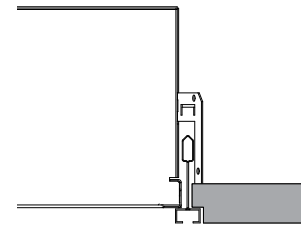

SLOT GRID

CEILING INTEGRATION DRYWALL

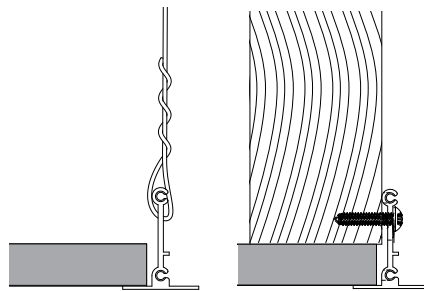

DRYWALL FLANGE KIT

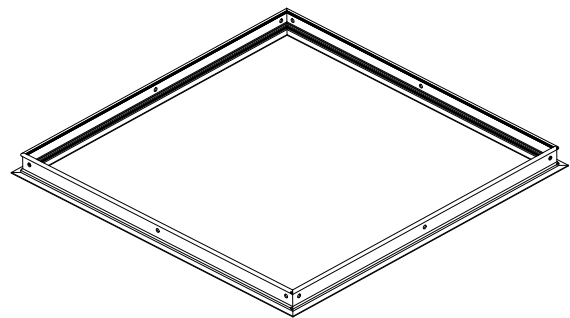

Required Aperture: 24.63 x 24.63 (625 x 625)

CONSTRUCTION

- Clear anodized aluminum lower rail
- Die formed 22 ga. steel housing
- Quick wire access plate and integral seismic restraint tabs/tie-offs
- Option for (K) drywall flange kit
- High reflectance diffuse white textured powdercoat

OPTICAL

- Anidolic optical structures with linear light extraction elements
- Precision extruded high transmittance clear acrylic lenses
- Long life LED system designed for typical TM21 lumen maintenance \geq L90 @ 60,000 h
- Available in CCTs 3000 K, 3500 K or 4000 K with CRI \geq 80 and R9 \geq 0, all with color accurate binning \leq 2 SDCM

ELECTRICAL

- Integral high efficiency drivers 120 – 277 V or 347 V; 50 - 60 Hz
- Power Factor $>$ 0.90
- Total Harmonic Distortion $<$ 20%
- F2:0 – 10 V Dim Range: 3 - 100%
- Optional Battery Pack
- Optional Lutron: Hi-lume H-Series EcoSystem LED drivers for 100 - 1% (PWM) dim range
- Optional flex whip: 6' prewired
- Surge Protection: Meets ANSI C82.11 spec and ANSI/IEEE C62.41
- Inrush Current: Meets NEMA 410

WEIGHT

- Maximum 16 lb. (7.3 kg)
- Maximum 20 lb. (9.1 kg) with battery pack

WARRANTY

- 5 year limited warranty on all components and workmanship

ENVIRONMENTAL

- Designed for use in damp or dry indoor environments with room side operating temperatures of 0 - 30° C (32 - 86° F)

INDEPENDENT TESTING

- IESNA LM79
- IESNA LM80 (LED@10,000 h)

APPROVALS

- UL Listed (USA + Canada)
- CCEA Chicago Plenum
- Lighting Facts[®]
- DesignLights Consortium[®]
- IC Rated

Product	Transom 2x2	Description	Performance Summary		Light (lm)	Energy (W)	Efficacy (lm/W)	Color Accuracy		
Version	TR1-22A40	2x2 LED A Lumens CCT 4000 K	CCT Color Temperature	4000 K	2660	23.49	113.2	83.6	11.4	< 2
Report	Based on 11555052.09			3500 K	2599	23.49	110.6	83.6	11.4	< 2
				3000 K	2514	23.57	106.7	81.9	3.4	< 2

100% Dn

CANDLEPOWER DISTRIBUTION

Vertical Angle	Horizontal Angle				Zonal Lumens
	0°	22.5°	45°	67.5°	
0°	622	622	622	622	622
5°	620	619	621	622	623
15°	599	614	697	762	789
25°	561	636	783	843	862
35°	504	639	765	816	826
45°	432	598	701	705	714
55°	347	511	569	582	575
65°	250	399	432	383	378
75°	146	262	228	180	145
85°	44	68	37	21	16
90°	2	1	1	1	1
95°					
105°					
115°					
125°					
135°					
145°					
155°					
165°					
175°					
180°					

LUMEN SUMMARY

Zone	Lumens	% Lamp	% Fixture	
0-30°	600	N.A.	23	
0-60°	2021	N.A.	76	
0-90°	2660	N.A.	100	
90-180°	0	N.A.	0	
Total Luminaire	0-180°	2660	N.A.	100

LUMINANCE DATA (CD/M²)

Vertical Angle	Horizontal Angle		
	0°	45°	90°
45°	1678	2720	2773
55°	1662	2722	2754
65°	1624	2804	2485
75°	1548	2419	1538
85°	1399	1153	498

CO-EFFICIENTS OF UTILIZATION

Floor Ceiling	80				70				20				30				10				0			
	70	50	30	10	70	50	30	10	50	50	10	10	50	10	10	10	50	10	10	10	50	10	10	10
0	119	119	119	119	116	116	116	111	111	111	111	106	106	102	102	100	100	100	100	100	100	100	100	
1	108	103	99	95	105	101	93	97	90	93	87	93	87	89	85	83	83	83	83	83	83	83	83	
2	98	89	82	76	95	87	75	83	73	80	71	77	70	68	68	68	68	68	68	68	68	68	68	
3	89	77	69	62	86	76	61	73	60	70	59	67	58	56	56	56	56	56	56	56	56	56	56	
4	81	68	59	52	78	67	51	64	51	62	50	59	49	47	47	47	47	47	47	47	47	47	47	
5	74	60	51	44	72	59	44	57	43	55	43	53	42	40	40	40	40	40	40	40	40	40	40	
6	68	54	44	38	66	53	38	51	37	49	37	48	37	34	34	34	34	34	34	34	34	34	34	
7	63	48	39	33	61	48	33	46	33	45	32	43	32	30	30	30	30	30	30	30	30	30	30	
8	58	44	35	29	56	43	29	42	29	41	29	39	28	26	26	26	26	26	26	26	26	26	26	
9	54	40	32	26	53	40	26	38	26	37	25	36	25	23	23	23	23	23	23	23	23	23	23	
10	51	37	29	23	49	36	23	35	23	34	23	33	23	21	21	21	21	21	21	21	21	21	21	

Integrating Sphere and Photometric results at 3000 & 4000K by an independent accredited testing laboratory per IES LM-79-2008 and ANSI C78.377-2011. Results for 3500K scaled based on integrating sphere results at 38W (C). Candlepower Distribution scaled per total lumens of Integrating Sphere results.

Product	Transom 2x2	Description	Performance Summary		Light (lm)	Energy (W)	Efficacy (lm/W)	Color Accuracy		
Version	TR1-22B40	2x2 LED B Lumens CCT 4000 K	CCT Color Temperature	4000 K	3220	29.16	110.4	83.6	11.2	< 2
Report	Based on 11555052.10			3500 K	3146	29.16	107.9	83.6	11.2	< 2
				3000 K	3071	29.16	105.3	81.5	2.1	< 2

100% Dn

CANDLEPOWER DISTRIBUTION

Vertical Angle	Horizontal Angle				Zonal Lumens
	0°	22.5°	45°	67.5°	
0°	753	753	753	753	753
5°	750	749	751	753	755
15°	725	743	844	923	955
25°	679	770	948	1021	1044
35°	611	773	926	988	1000
45°	523	724	848	854	864
55°	420	619	688	705	696
65°	303	482	522	463	457
75°	177	317	276	218	176
85°	54	83	44	26	19
90°	3	2	2	1	1
95°					
105°					
115°					
125°					
135°					
145°					
155°					
165°					
175°					
180°					

LUMEN SUMMARY

Zone	Lumens	% Lamp	% Fixture	
0-30°	727	N.A.	23	
0-60°	2447	N.A.	76	
0-90°	3220	N.A.	100	
90-180°	0	N.A.	0	
Total Luminaire	0-180°	3220	N.A.	100

LUMINANCE DATA (CD/M²)

Vertical Angle	Horizontal Angle		
	0°	45°	90°
45°	2032	3293	3357
55°	2011	3295	3333
65°	1966	3394	3009
75°	1874	2927	1862
85°	1695	1396	602

CO-EFFICIENTS OF UTILIZATION

Floor Ceiling	80				70				20				30				10				0			
	70	50	30	10	70	50	30	10	50	50	10	10	50	10	10	10	50	10	10	10	50	10	10	10
0	119	119	119	119	116	116	116	111	111	111	111	106	106	102	102	100	100	100	100	100	100	100	100	100
1	108	103	99	95	105	101	93	97	90	93	87	93	87	89	85	83	83	83	83	83	83	83	83	83
2	98	89	82	76	95	87	75	83	73	80	71	77	70	68	68	68	68	68	68	68	68	68	68	68
3	89	77	69	62	86	76	61	73	60	70	59	67	58	56	56	56	56	56	56	56	56	56	56	56
4	81	68	59	52	78	67	51	64	51	62	50	59	49	47	47	47	47	47	47	47	47	47	47	47
5	74	60	51	44	72	59	44	57	43	55	43	53	42	40	40	40	40	40	40	40	40	40	40	40
6	68	54	44	38	66	53	38	51	37	49	37	48	37	34	34	34	34	34	34	34	34	34	34	34
7	63	48	39	33	61	48	33	46	33	45	32	43	32	30	30	30	30	30	30	30	30	30	30	30
8	58	44	35	29	56	43	29	42	29	41	29	39	28	26	26	26	26	26	26	26	26	26	26	26
9	54	40	32	26	53	40	26	38	26	37	25	36	25	23	23	23	23	23	23	23	23	23	23	23
10	51	37	29	23	49	36	23	35	23	34	23	33	23	21	21	21	21	21	21	21	21	21	21	21

Product	Transom 2x2	Description	Performance Summary					Light (lm)	Energy (W)	Efficacy (lm/W)	Color Accuracy		
Version	TR1-22C40	2x2 LED C Lumens CCT 4000 K	CCT Color Temperature	4000 K	4074	39.24	103.8	83.6	10.9	< 2			
Report	Based on 11555052.13			3500 K	3980	39.24	101.4	83.6	10.9	< 2			
				3000 K	3886	39.43	98.6	81.5	2.1	< 2			

100% Dn

CANDLEPOWER DISTRIBUTION

Vertical Angle	Horizontal Angle					Zonal Lumens
	0°	22.5°	45°	67.5°	90°	
0°	953	953	953	953	953	953
5°	949	948	950	952	955	92
15°	918	940	1068	1168	1208	302
25°	859	974	1199	1291	1321	525
35°	772	978	1172	1250	1265	691
45°	662	916	1073	1080	1094	762
55°	532	783	871	892	881	724
65°	383	610	661	586	586	579
75°	223	401	349	275	222	329
85°	68	105	56	32	24	71
90°	3	2	2	1	1	

LUMEN SUMMARY

Zone	Lumens	% Lamp	% Fixture
0-30°	919	N.A.	23
0-60°	3096	N.A.	76
0-90°	4074	N.A.	100
90-180°	0	N.A.	0
Total Luminaire	4075	N.A.	100

LUMINANCE DATA (CD/M²)

Vertical Angle	0°	45°	90°
	45°	2570	4166
55°	2544	4169	4218
65°	2487	4294	3807
75°	2370	3704	2356
85°	2145	1767	759

CO-EFFICIENTS OF UTILIZATION

Floor Ceiling Wall	80				70				20					
	70	50	30	10	70	50	30	10	50	10	50	10		
0	119	119	119	119	116	116	116	111	111	106	106	102	102	100
1	108	103	99	95	105	101	93	97	90	93	87	89	85	83
2	98	89	82	76	95	87	75	83	73	80	71	77	70	68
3	89	77	69	62	86	76	61	73	60	70	59	67	58	56
4	81	68	59	52	78	67	51	64	51	62	50	59	49	47
5	74	60	51	44	72	59	44	57	43	55	43	53	42	40
6	68	54	44	38	66	53	38	51	37	49	37	48	37	34
7	63	48	39	33	61	48	33	46	33	45	32	43	32	30
8	58	44	35	29	56	43	29	42	29	41	29	39	28	26
9	54	40	32	26	53	40	26	38	26	37	25	36	25	23
10	51	37	29	23	49	36	23	35	23	34	23	33	23	21

Light Output (Lumens) **4074**
Watts **39.24**
Lumens per Watt (Efficacy) **103.82**

Color Accuracy **83**

Light Color **4000 (Bright White)**

Integrating Sphere and Photometric results at 3000 & 4000K by an independent accredited testing laboratory per IES LM-79-2008 and ANSI C78.377-2011. Results for 3500K scaled based on integrating sphere results at 38W (C). Candlepower Distribution scaled per total lumens of Integrating Sphere results.