



INBOX 2X4 NB2-24

Specification Data



CROSS SECTION

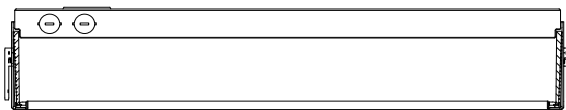

DIMENSIONS inches (mm)

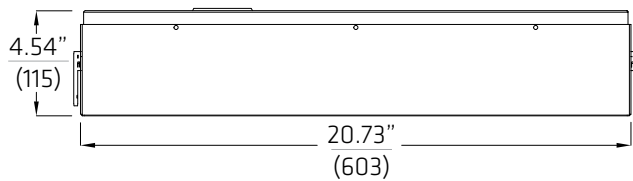

FRONT VIEW

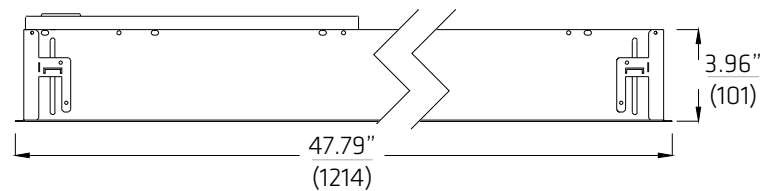

SIDE VIEW

Luminaire	INBOX 2 X 4 (NB2-24)	Type
Project		
Product		
Notes		



Performance Summary	Inbox 2 x 4			
	A	B	C	D
Light (lm)	2900	3500	4500	5400
Energy (W)	23	29	38	47
Efficacy (lm/W)	126	122	121	115
Color Rendering (CRI)	80+	80+	80+	80+
Color Accuracy (SDCM)	< 2	< 2	< 2	< 2
L70 Estimate (h)	200,000	200,000	200,000	200,000
Lumen Maintenance per TM21 (@ 60,000 h)	L90	L90	L90	L90

DLC qualified for each lumen output (A, B, C, D) in 3000K, 3500K & 4000K (except 3000K in "A" lumens). Summary values are nominal and based on 4000K CCT.

SPECIFICATION

NB2		24						OPTIONS	
1	2	3	4	5	6				
1. FAMILY	2. SIZE	3. ENERGY ¹	4. CCT	5. DRIVER	6. VOLTAGE	OPTIONS			
NB2 Inbox	12 1 x 2 (2-sided optics)	A 23 W	30 3000 K	E1 eldoLED ECO 0-10V Dim 1%	M 120 - 277 V	B Battery Pack ⁴ C Chicago Plenum F 6' Flex Whip K Drywall Flange Kit			
	14 1 x 4 (2-sided optics)	B 29 W	35 3500 K	E2 eldoLED SOLO 0-10V Dim 0.1%					
	22 2 x 2 (2-sided optics)	C 38 W	40 4000 K	E3 eldoLED ECO DALI 1%	3 347 V ³				
	24 2 x 4 (2-sided optics)	D 47 W ²		E4 eldoLED SOLO DALI Dim 0.1%					
NB1 Inbox	22 2 x 2 (4-sided optics)			F1 Factory Non- Dim F2 Factory 0-10V Dim 3% L1 Lutron Hi-Lume 1%-H EcoSystem					

NOTES			
¹ Add 4W to above for 347V with E1-4/L1	² 1 x 4 2 x 4 2 x 2 (4 sided) only	³ 347 V Driver for F1/F2 347 V Transformer & Driver E1-4/L1	⁴ Available for 120-277V

CEILING INTEGRATION GRID

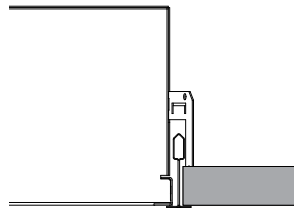

FLAT GRID

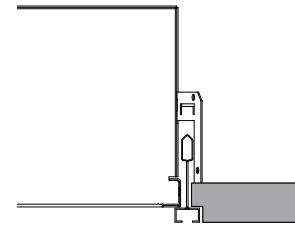

SLOT GRID

CEILING INTEGRATION DRYWALL

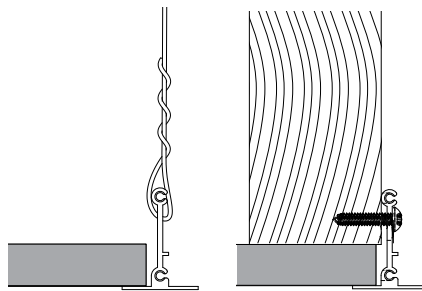

DRYWALL FLANGE KIT

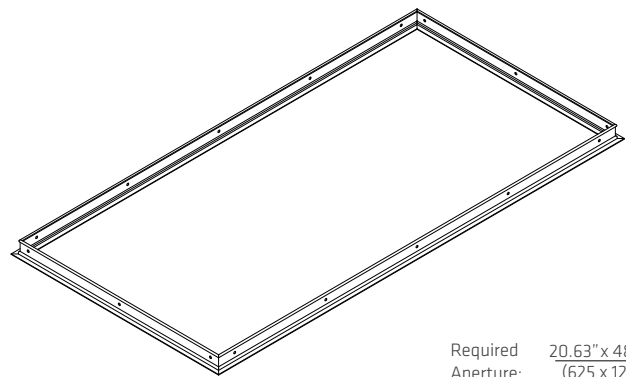

Required Aperture: 20.63" x 48.63"
(625 x 1235)

CONSTRUCTION

- Die formed 22 ga. steel housing
- Quick wire access plate and integral seismic restraint tabs/tie-offs
- Option for (K) drywall flange kit
- High reflectance diffuse white textured powdercoat

OPTICAL

- Anidolic optical structures with linear light extraction elements
- Precision extruded high transmittance clear acrylic lenses
- Long life LED system designed for typical TM21 lumen maintenance \geq L90 @ 60,000 h
- Available in CCTs 3000 K, 3500 K or 4000 K with CRI \geq 80 and R9 \geq 0, all with color accurate binning \leq 2 SDCM

ELECTRICAL

- Integral high efficiency drivers 120 - 277 V or 347 V; 50 - 60 Hz
- Power Factor $>$ 0.90
- Total Harmonic Distortion $<$ 20%
- F2:0 - 10 V Dim Range: 3 - 100%
- Optional Battery Pack
- Optional Lutron: Hi-lume H-Series EcoSystem LED drivers for 100 - 1% (PWM) dim range
- Optional flex whip: 6' prewired
- Surge Protection: Meets ANSI C82.11 spec and ANSI/IEEE C62.41
- Inrush Current: Meets NEMA 410

WEIGHT

- Maximum 25 lb (11.3 kg)
- Maximum 29 lb (13.2 kg) with battery pack

WARRANTY

- 5 year limited warranty on all components and workmanship

ENVIRONMENTAL

- Designed for use in damp or dry indoor environments with room side operating temperatures of 0 - 30° C (32 - 86° F)

INDEPENDENT TESTING

- IESNA LM79
- IESNA LM80 (LED@ 10,000 h)

APPROVALS

- UL Listed (USA + Canada)
- CCEA Chicago Plenum
- DesignLights Consortium[®]
- Lighting Facts[®]
- IC Rated

Product	Inbox 2x4	Description	Performance Summary		Light (lm)	Energy (W)	Efficacy (lm/W)	Color Accuracy		
Version	NB2-24A40	2x4 LED A Lumens CCT 4000 K	CCT Color Temperature	4000 K	2907	23	126	83	4	< 2
Report	FLUXWERX			3500 K	2807	23	122	83	4	< 2
				3000 K	2708	23	118	83	4	< 2



100% Dn

CANDLEPOWER DISTRIBUTION						
Vertical Angle	Horizontal Angle				Zonal Lumens	
	0°	22.5°	45°	67.5°		90°
0°	548	548	548	548	548	
5°	543	548	549	560	571	
15°	529	569	699	779	809	
25°	499	641	823	904	926	
35°	454	671	844	880	889	
45°	395	653	783	770	772	
55°	324	583	646	611	580	
65°	243	467	485	386	374	
75°	160	332	266	237	239	
85°	62	136	79	59	57	
90°	1	5	4	4	5	
95°						
105°						
115°						
125°						
135°						
145°						
155°						
165°						
175°						
180°						

LUMEN SUMMARY				
Zone	Lumens	% Lamp	% Fixture	
0-30°	604	N.A.	21	
0-60°	2131	N.A.	73	
0-90°	2906	N.A.	100	
90-180°	0	N.A.	0	
Total Luminaire	0-180°	2907	N.A.	100

LUMINANCE DATA (CD/M ²)									
Vertical Angle	0°			45°			90°		
	45°	827	1640	1616	838	1668	1496	852	1700
55°	917	1520	1365	917	1520	1365	917	1520	1365
65°	1053	1339	970	1053	1339	970	1053	1339	970

CO-EFFICIENTS OF UTILIZATION																	
Floor Ceiling Wall	80				70				20		30		10		0		
	70	50	30	10	70	50	10	50	10	50	10	50	10	50	10	50	10
0	119	119	119	119	116	116	116	111	111	106	106	102	102	100	100	100	100
1	107	102	97	93	105	100	91	95	88	91	86	88	83	81	81	81	81
2	97	88	80	74	94	86	73	82	71	79	69	75	68	65	65	65	65
3	87	76	67	60	85	74	59	71	58	68	57	66	56	54	54	54	54
4	79	66	57	50	77	65	49	62	49	60	48	58	47	45	45	45	45
5	73	59	49	42	70	58	42	55	41	53	41	51	40	38	38	38	38
6	67	52	43	36	65	51	36	50	36	48	35	46	35	33	33	33	33
7	62	47	38	31	60	46	31	45	31	43	31	42	30	28	28	28	28
8	57	43	34	28	55	42	27	41	27	39	27	38	27	25	25	25	25
9	53	39	30	24	52	38	24	37	24	36	24	35	24	22	22	22	22
10	50	36	27	22	48	35	22	34	22	33	22	32	21	20	20	20	20

Integrating Sphere and Photometric results at 4000K , 47W (D) by an independent accredited testing laboratory per IES LM-79-2008 and ANSI C78.377-2011. Results for 3000K, 3500K scaled based on integrating sphere results at 47W (D) and 2x2-4sided integrated sphere results for Lumen outputs A, B, C. Candlepower Distribution scaled per total lumens of Integrating Sphere results.

Product	Inbox 2x4	Description	Performance Summary		Light (lm)	Energy (W)	Efficacy (lm/W)	Color Accuracy		
Version	NB2-24B40	2x4 LED B Lumens CCT 4000 K	CCT Color Temperature	4000 K	3525	28.9	122	83	4	< 2
Report	FLUXWERX			3500 K	3404	28.5	120	83	4	< 2
				3000 K	3284	28.8	114	82.7	4.4	< 2



100% Dn

CANDLEPOWER DISTRIBUTION						
Vertical Angle	Horizontal Angle				Zonal Lumens	
	0°	22.5°	45°	67.5°		90°
0°	665	665	665	665	665	
5°	659	664	666	679	692	
15°	642	689	848	945	981	
25°	605	778	998	1096	1123	
35°	550	814	1023	1068	1078	
45°	479	792	950	934	936	
55°	393	707	784	741	703	
65°	295	567	588	468	454	
75°	194	403	322	287	289	
85°	75	164	96	72	69	
90°	1	6	5	5	6	
95°						
105°						
115°						
125°						
135°						
145°						
155°						
165°						
175°						
180°						

LUMEN SUMMARY				
Zone	Lumens	% Lamp	% Fixture	
0-30°	733	N.A.	21	
0-60°	2585	N.A.	73	
0-90°	3525	N.A.	100	
90-180°	0	N.A.	0	
Total Luminaire	0-180°	3525	N.A.	100

LUMINANCE DATA (CD/M ²)									
Vertical Angle	0°			45°			90°		
	45°	1003	1988	1959	1016	2023	1814	1033	2061
55°	1111	1843	1655	1111	1843	1655	1111	1843	1655
65°	1278	1624	1176	1278	1624	1176	1278	1624	1176

CO-EFFICIENTS OF UTILIZATION																	
Floor Ceiling Wall	80				70				20		30		10		0		
	70	50	30	10	70	50	10	50	10	50	10	50	10	50	10	50	10
0	119	119	119	119	116	116	116	111	111	106	106	102	102	100	100	100	100
1	107	102	97	93	105	100	91	95	88	91	86	88	83	81	81	81	81
2	97	88	80	74	94	86	73	82	71	79	69	75	68	65	65	65	65
3	87	76	67	60	85	74	59	71	58	68	57	66	56	54	54	54	54
4	79	66	57	50	77	65	49	62	49	60	48	58	47	45	45	45	45
5	73	59	49	42	70	58	42	55	41	53	41	51	40	38	38	38	38
6	67	52	43	36	65	51	36	50	36	48	35	46	35	33	33	33	33
7	62	47	38	31	60	46	31	45	31	43	31	42	30	28	28	28	28
8	57	43	34	28	55	42	27	41	27	39	27	38	27	25	25	25	25
9	53	39	30	24	52	38	24	37	24	36	24	35	24	22	22	22	22
10	50	36	27	22	48	35	22	34	22	33	22	32	21	20	20	20	20

Product	Inbox 2x4	Description	Performance Summary		Light (lm)	Energy (W)	Efficacy (lm/W)	Color Accuracy		
Version	NB2-24C40	2x4 LED C Lumens CCT 4000 K	CCT Color Temperature	4000 K	4543	37.5	121	83	4	< 2
Report	FLUXWERX			3500 K	4387	37.5	117	83	4	< 2
				3000 K	4232	37.5	113	83	4	< 2

100% Dn

CANDLEPOWER DISTRIBUTION

Vertical Angle	Horizontal Angle				Zonal Lumens
	0°	22.5°	45°	67.5°	90°
0°	857	857	857	857	857
5°	849	856	858	875	892
15°	827	889	1093	1218	1264
25°	780	1002	1286	1413	1447
35°	709	1049	1319	1376	1389
45°	617	1020	1224	1204	1206
55°	507	912	1010	954	906
65°	380	730	758	603	585
75°	250	519	415	370	373
85°	97	212	123	93	89
90°	2	8	7	7	7
95°					
105°					
115°					
125°					
135°					
145°					
155°					
165°					
175°					
180°					

LUMEN SUMMARY

Zone	Lumens	% Lamp	% Fixture
0-30°	944	N.A.	21
0-60°	3331	N.A.	73
0-90°	4542	N.A.	100
90-180°	0	N.A.	0
Total Luminaire	4543	N.A.	100

LUMINANCE DATA (CD/M²)

Vertical Angle	0°	45°	90°
45°	1293	2563	2525
55°	1309	2607	2338
65°	1331	2656	2050
75°	1432	2375	2132
85°	1648	2092	1516

CO-EFFICIENTS OF UTILIZATION

Floor Ceiling Wall	80				70				20				50				30				10				0			
	70	50	30	10	70	50	30	10	50	10	50	10	50	10	50	10	50	10	50	10	50	10	50	10	50	10	50	10
0	119	119	119	119	116	116	116	111	111	106	106	102	102	100														
1	107	102	97	93	105	100	91	95	88	91	86	88	83	81														
2	97	88	80	74	94	86	73	82	71	79	69	75	68	65														
3	87	76	67	60	85	74	59	71	58	68	57	66	56	54														
4	79	66	57	50	77	65	49	62	49	60	48	58	47	45														
5	73	59	49	42	70	58	42	55	41	53	41	51	40	38														
6	67	52	43	36	65	51	36	50	36	48	35	46	35	33														
7	62	47	38	31	60	46	31	45	31	43	31	42	30	28														
8	57	43	34	28	55	42	27	41	27	39	27	38	27	25														
9	53	39	30	24	52	38	24	37	24	36	24	35	24	22														
10	50	36	27	22	48	35	22	34	22	33	22	32	21	20														

Integrating Sphere and Photometric results at 4000K , 47W (D) by an independent accredited testing laboratory per IES LM-79-2008 and ANSI C78.377-2011. Results for 3000K, 3500K scaled based on integrating sphere results at 47W (D) and 2x2-4sided integrated sphere results for Lumen outputs A, B, C. Candlepower Distribution scaled per total lumens of Integrating Sphere results.

Product	Inbox 2x4	Description	Performance Summary		Light (lm)	Energy (W)	Efficacy (lm/W)	Color Accuracy		
Version	NB2-24D40	2x4 LED D Lumens CCT 4000 K	CCT Color Temperature	4000 K	5432	47.2	115	82.8	4	< 2
Report	11660485.21			3500 K	5247	47	111	83.8	4	< 2
				3000 K	5061	47.4	107	82.5	2.7	< 2

100% Dn

CANDLEPOWER DISTRIBUTION

Vertical Angle	Horizontal Angle				Zonal Lumens
	0°	22.5°	45°	67.5°	90°
0°	1025	1025	1025	1025	1025
5°	1015	1024	1026	1046	1067
15°	989	1063	1307	1456	1511
25°	933	1199	1538	1689	1730
35°	848	1255	1577	1645	1661
45°	738	1220	1463	1440	1442
55°	606	1090	1208	1141	1083
65°	454	873	907	721	700
75°	299	621	496	442	446
85°	116	253	147	111	107
90°	2	10	8	8	9
95°					
105°					
115°					
125°					
135°					
145°					
155°					
165°					
175°					
180°					

LUMEN SUMMARY

Zone	Lumens	% Lamp	% Fixture
0-30°	1129	N.A.	21
0-60°	3983	N.A.	73
0-90°	5432	N.A.	100
90-180°	0	N.A.	0
Total Luminaire	5432	N.A.	100

LUMINANCE DATA (CD/M²)

Vertical Angle	0°	45°	90°
45°	1546	3064	3020
55°	1565	3118	2796
65°	1592	3176	2452
75°	1712	2840	2549
85°	1971	2503	1813

CO-EFFICIENTS OF UTILIZATION

Floor Ceiling Wall	80				70				20				50				30				10				0			
	70	50	30	10	70	50	30	10	50	10	50	10	50	10	50	10	50	10	50	10	50	10	50	10	50	10	50	10
0	119	119	119	119	116	116	116	111	111	106	106	102	102	100														
1	107	102	97	93	105	100	91	95	88	91	86	88	83	81														
2	97	88	80	74	94	86	73	82	71	79	69	75	68	65														
3	87	76	67	60	85	74	59	71	58	68	57	66	56	54														
4	79	66	57	50	77	65	49	62	49	60	48	58	47	45														
5	73	59	49	42	70	58	42	55	41	53	41	51	40	38														
6	67	52	43	36	65	51	36	50	36	48	35	46	35	33														
7	62	47	38	31	60	46	31	45	31	43	31	42	30	28														
8	57	43	34	28	55	42	27	41	27	39	27	38	27	25														
9	53	39	30	24	52	38	24	37	24	36	24	35	24	22														
10	50	36	27	22	48	35	22	34	22	33	22	32	21	20														

LED lighting facts
A Measure of Light

Light Output (Lumens) **5432**
Watts **47.19**
Lumens per Watt (Efficacy) **115.11**

Color Accuracy (CRI) **83**

Light Color (CCT) **4000 (Bright White)**

2700K 3000K 4000K 6500K

All results are according to IESNA LM-79-2008. Approved Method for the Electrical and Photometric Testing of Solid State Lighting. The U.S. Department of Energy (DOE) certifies product test data and results.

Visit www.lightingfacts.com for the Label Reference Guide.

Registration Number: 1444-119176 (03/2017)
Model Number: NB24D40P1P2E1R2E3E4E5E6E7E8E9E10E11E12E13E14E15E16E17E18E19E20E21E22E23E24E25E26E27E28E29E30E31E32E33E34E35E36E37E38E39E40E41E42E43E44E45E46E47E48E49E50E51E52E53E54E55E56E57E58E59E60E61E62E63E64E65E66E67E68E69E70E71E72E73E74E75E76E77E78E79E80E81E82E83E84E85E86E87E88E89E90E91E92E93E94E95E96E97E98E99E100E101E102E103E104E105E106E107E108E109E110E111E112E113E114E115E116E117E118E119E120E121E122E123E124E125E126E127E128E129E130E131E132E133E134E135E136E137E138E139E140E141E142E143E144E145E146E147E148E149E150E151E152E153E154E155E156E157E158E159E160E161E162E163E164E165E166E167E168E169E170E171E172E173E174E175E176E177E178E179E180E181E182E183E184E185E186E187E188E189E190E191E192E193E194E195E196E197E198E199E200E201E202E203E204E205E206E207E208E209E210E211E212E213E214E215E216E217E218E219E220E221E222E223E224E225E226E227E228E229E230E231E232E233E234E235E236E237E238E239E240E241E242E243E244E245E246E247E248E249E250E251E252E253E254E255E256E257E258E259E260E261E262E263E264E265E266E267E268E269E270E271E272E273E274E275E276E277E278E279E280E281E282E283E284E285E286E287E288E289E290E291E292E293E294E295E296E297E298E299E300E301E302E303E304E305E306E307E308E309E310E311E312E313E314E315E316E317E318E319E320E321E322E323E324E325E326E327E328E329E330E331E332E333E334E335E336E337E338E339E340E341E342E343E344E345E346E347E348E349E350E351E352E353E354E355E356E357E358E359E360E361E362E363E364E365E366E367E368E369E370E371E372E373E374E375E376E377E378E379E380E381E382E383E384E385E386E387E388E389E390E391E392E393E394E395E396E397E398E399E400E401E402E403E404E405E406E407E408E409E410E411E412E413E414E415E416E417E418E419E420E421E422E423E424E425E426E427E428E429E430E431E432E433E434E435E436E437E438E439E440E441E442E443E444E445E446E447E448E449E450E451E452E453E454E455E456E457E458E459E460E461E462E463E464E465E466E467E468E469E470E471E472E473E474E475E476E477E478E479E480E481E482E483E484E485E486E487E488E489E490E491E492E493E494E495E496E497E498E499E500E501E502E503E504E505E506E507E508E509E510E511E512E513E514E515E516E517E518E519E520E521E522E523E524E525E526E527E528E529E530E531E532E533E534E535E536E537E538E539E540E541E542E543E544E545E546E547E548E549E550E551E552E553E554E555E556E557E558E559E560E561E562E563E564E565E566E567E568E569E570E571E572E573E574E575E576E577E578E579E580E581E582E583E584E585E586E587E588E589E590E591E592E593E594E595E596E597E598E599E600E601E602E603E604E605E606E607E608E609E610E611E612E613E614E615E616E617E618E619E620E621E622E623E624E625E626E627E628E629E630E631E632E633E634E635E636E637E638E639E640E641E642E643E644E645E646E647E648E649E650E651E652E653E654E655E656E657E658E659E660E661E662E663E664E665E666E667E668E669E670E671E672E673E674E675E676E677E678E679E680E681E682E683E684E685E686E687E688E689E690E691E692E693E694E695E696E697E698E699E700E701E702E703E704E705E706E707E708E709E710E711E712E713E714E715E716E717E718E719E720E721E722E723E724E725E726E727E728E729E730E731E732E733E734E735E736E737E738E739E740E741E742E743E744E745E746E747E748E749E750E751E752E753E754E755E756E757E758E759E760E761E762E763E764E765E766E767E768E769E770E