



TRANSOM 1 x 4 TR1-14

Specification Data



CROSS SECTION

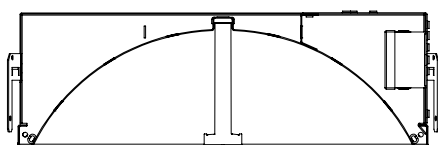

DIMENSIONS inches (mm)

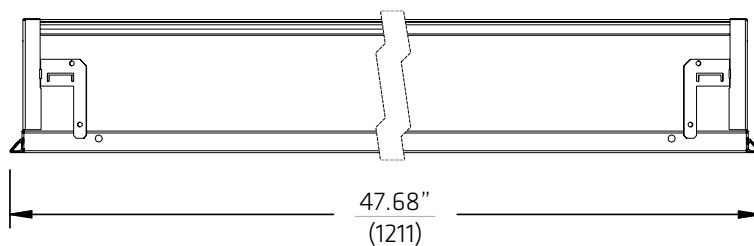
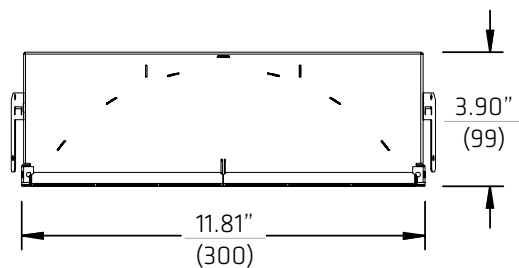

Luminaire	TRANSOM - 1 X 4 (TR1-14)	Type
Project		
Product		
Notes		



Performance Summary	Transom 1 x 4			
	A	B	C	D
Light (lm)	2600	3150	4050	4750
Energy (W)	23	29	38	47
Efficacy (lm/W)	112	110	106	102
Color Rendering (CRI)	80+	80+	80+	80+
Color Accuracy (SDCM)	< 2	< 2	< 2	< 2
L70 Estimate (h)	200,000	200,000	200,000	200,000
Lumen Maintenance per TM21 (@ 60,000 h)	L90	L90	L90	L90

DLC qualified for each lumen output (A,B,C,D) in 3000K, 3500K & 4000K. Summary values are nominal and based on 4000K CCT

SPECIFICATION

TR1	14						
1	2	3	4	5	6	OPTIONS	
1. FAMILY	2. SIZE	3. ENERGY <sup>2</sup>	4. CCT	5. DRIVER	6. VOLTAGE	OPTIONS	
<b>TR1</b> Transom	<b>14</b> 1 x 4 <b>22</b> 2 x 2 <b>24</b> 2 x 4 <b>52</b> 20 x 24 <b>54</b> 20 x 48 <sup>1</sup>	<b>A</b> 23 W <b>B</b> 29 W <b>C</b> 38 W <b>D</b> 47 W <sup>3</sup>	<b>30</b> 3000 K <b>35</b> 3500 K <b>40</b> 4000 K	<b>E1</b> eldoLED ECO 0-10V Dim 1% <b>E2</b> eldoLED SOLO 0-10V Dim 0.1% <b>E3</b> eldoLED ECO DALI 1% <b>E4</b> eldoLED SOLO DALI Dim 0.1% <b>F1</b> Factory Non- Dim <b>F2</b> Factory 0-10V Dim 3% <b>L1</b> Lutron Hi-Lume 1%-H EcoSystem	<b>M</b> 120 - 277 V <b>3</b> 347 V <sup>4</sup> <small><sup>4</sup>347 V Driver for F1/F2 347 V Transformer &amp; Driver E1-4/L1</small>	<b>B</b> Battery Pack <sup>5</sup> <b>C</b> Chicago Plenum <b>F</b> 6' Flex Whip <b>K</b> Drywall Flange Kit <small><sup>5</sup> Available for 120-277V</small>	
	<small><sup>1</sup>Optional filler panels available for 20 x 60</small>	<small><sup>2</sup>Add 4W to above for 347 V with E1-4/L1 <sup>3</sup>1 x 4   2 x 4   20 x 48 only</small>					

CEILING INTEGRATION GRID

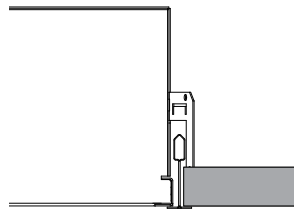

FLAT GRID

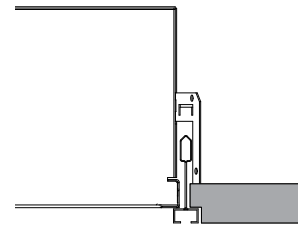

SLOT GRID

CEILING INTEGRATION DRYWALL

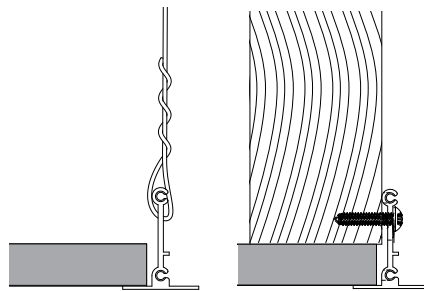

DRYWALL FLANGE KIT

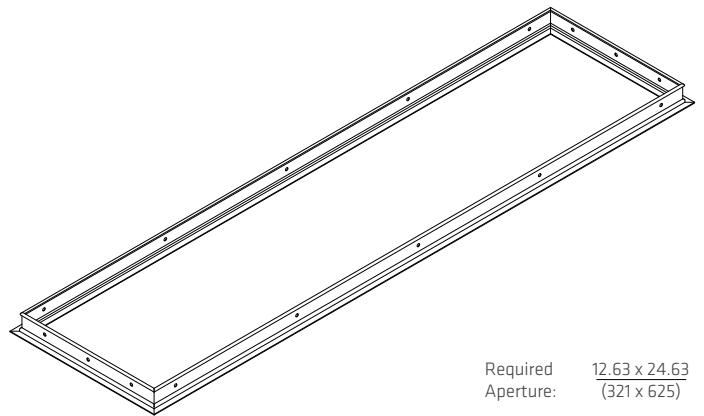

Required Aperture: 12.63 x 24.63 (321 x 625)

**CONSTRUCTION**

- Clear anodized aluminum lower rail
- Die formed 22 ga. steel housing
- Quick wire access plate and integral seismic restraint tabs/tie-offs
- Option for (K) drywall flange kit
- High reflectance diffuse white textured powdercoat

**OPTICAL**

- Anidolic optical structures with linear light extraction elements
- Precision extruded high transmittance clear acrylic lenses
- Long life LED system designed for typical TM21 lumen maintenance  $\geq$  L90 @ 60,000 h
- Available in CCTs 3000 K, 3500 K or 4000 K with CRI  $\geq$  80 and R9  $\geq$  0, all with color accurate binning  $\leq$  2 SDCM

**ELECTRICAL**

- Integral high efficiency drivers 120 – 277 V or 347 V; 50 - 60 Hz
- Power Factor  $>$  0.90
- Total Harmonic Distortion  $<$  20%
- F2:0 – 10 V Dim Range: 3 - 100%
- Optional Battery Pack
- Optional Lutron: Hi-lume H-Series EcoSystem LED drivers for 100 - 1% (PWM) dim range
- Optional flex whip: 6' prewired
- Surge Protection: Meets ANSI C82.11 spec and ANSI/IEEE C62.41
- Inrush Current: Meets NEMA 410

**WEIGHT**

- Maximum 20.5 lb. (9.3 kg)
- Maximum 24.5 lb. (11.1 kg) with battery pack

**WARRANTY**

- 5 year limited warranty on all components and workmanship

**ENVIRONMENTAL**

- Designed for use in damp or dry indoor environments with room side operating temperatures of 0 - 30° C (32 - 86° F)

**INDEPENDENT TESTING**

- IESNA LM79
- IESNA LM80 (LED@10,000 h)

**APPROVALS**

- UL Listed (USA + Canada)
- CCEA Chicago Plenum
- Lighting Facts®
- DesignLights Consortium®
- IC Rated

Product	Transom 1x4	Description	Performance Summary		Light (lm)	Energy (W)	Efficacy (lm/W)	Color Accuracy		
Version	TR1-14A40	1x4 LED A Lumens CCT 4000 K	CCT Color Temperature	4000 K	2596	23.16	112.1	83.2	8.9	< 2
Report	Based on 11555052.02			3500 K	2580	23.16	111.4	83.2	8.9	< 2
				3000K	2536	23.14	109.6	82.5	6.4	< 2

### CANDLEPOWER DISTRIBUTION

Vertical Angle	Horizontal Angle				Zonal Lumens
	0°	22.5°	45°	67.5°	90°
0°	694	694	694	694	694
5°	693	693	701	708	712
15°	672	693	753	796	812
25°	632	694	803	864	879
35°	572	675	798	812	808
45°	496	631	705	683	676
55°	406	543	556	519	490
65°	304	412	379	248	227
75°	185	262	141	100	92
85°	48	50	24	19	19
90°	1	2	2	2	2
95°					
105°					
115°					
125°					
135°					
145°					
155°					
165°					
175°					
180°					

### LUMEN SUMMARY

Zone	Lumens	% Lamp	% Fixture
0-30°	639	N.A.	25
0-60°	2064	N.A.	80
0-90°	2596	N.A.	100
90-180°	0	N.A.	0
Total Luminaire	2596	N.A.	100

### LUMINANCE DATA (CD/M<sup>2</sup>)

Vertical Angle	0°	45°	90°
45°	2098	2985	2861
55°	2119	2904	2560
65°	2155	2683	1610
75°	2145	1625	1065
85°	1659	838	660

### CO-EFFICIENTS OF UTILIZATION

Floor Ceiling	80				70				20				30				10				0			
	70	50	30	10	70	50	30	10	50	50	10	50	10	50	10	50	10	50	10	50	10	50	10	
0	119	119	119	119	116	116	116	111	111	106	106	102	102	100	100	100	100	100	100	100	100	100		
1	109	104	100	96	106	102	94	97	91	94	88	90	86	84	84	84	84	84	84	84	84	84		
2	99	90	83	78	96	88	77	85	75	82	73	79	72	69	69	69	69	69	69	69	69	69		
3	90	79	71	64	87	77	64	74	62	72	61	69	60	58	58	58	58	58	58	58	58	58		
4	82	70	61	54	80	68	53	66	53	63	52	61	51	49	49	49	49	49	49	49	49	49		
5	75	62	53	46	73	61	46	59	45	57	45	55	44	42	42	42	42	42	42	42	42	42		
6	69	55	46	40	67	55	40	53	39	51	39	49	39	36	36	36	36	36	36	36	36	36		
7	64	50	41	35	62	49	35	48	34	46	34	45	34	32	32	32	32	32	32	32	32	32		
8	59	46	37	31	58	45	31	43	31	42	30	41	30	28	28	28	28	28	28	28	28	28		
9	55	42	33	28	54	41	27	40	27	39	27	38	27	25	25	25	25	25	25	25	25	25		
10	52	38	30	25	50	38	25	37	25	36	24	35	24	23	23	23	23	23	23	23	23	23		

Integrating Sphere and Photometric results at 4000K by an independent accredited testing laboratory per IES LM-79-2008 and ANSI C78.377-2011. Results for 3000K & 3500K scaled based on integrating sphere results at 47W (D). Candlepower Distribution scaled per total lumens of Integrating Sphere results.

Product	Transom 1x4	Description	Performance Summary		Light (lm)	Energy (W)	Efficacy (lm/W)	Color Accuracy		
Version	TR1-14B40	1x4 LED B Lumens CCT 4000 K	CCT Color Temperature	4000 K	3144	28.52	110.3	83.1	8.7	< 2
Report	Based on 11555052.03			3500 K	3125	28.52	109.6	83.1	8.7	< 2
				3000K	3106	28.52	108.9	82.2	5.2	< 2

### CANDLEPOWER DISTRIBUTION

Vertical Angle	Horizontal Angle				Zonal Lumens
	0°	22.5°	45°	67.5°	90°
0°	840	840	840	840	840
5°	840	840	848	857	862
15°	814	840	912	964	984
25°	765	840	972	1047	1064
35°	693	817	966	983	979
45°	600	764	854	827	818
55°	492	658	674	629	594
65°	368	499	459	300	275
75°	225	317	170	121	112
85°	59	61	30	23	23
90°	1	2	2	2	3
95°					
105°					
115°					
125°					
135°					
145°					
155°					
165°					
175°					
180°					

### LUMEN SUMMARY

Zone	Lumens	% Lamp	% Fixture
0-30°	773	N.A.	25
0-60°	2500	N.A.	80
0-90°	3144	N.A.	100
90-180°	0	N.A.	0
Total Luminaire	3144	N.A.	100

### LUMINANCE DATA (CD/M<sup>2</sup>)

Vertical Angle	0°	45°	90°
45°	2541	3615	3465
55°	2567	3517	3100
65°	2610	3249	1950
75°	2597	1969	1291
85°	2010	1017	797

### CO-EFFICIENTS OF UTILIZATION

Floor Ceiling	80				70				20				30				10				0			
	70	50	30	10	70	50	30	10	50	50	10	50	10	50	10	50	10	50	10	50	10	50	10	50
0	119	119	119	119	116	116	116	111	111	106	106	102	102	100	100	100	100	100	100	100	100	100	100	100
1	109	104	100	96	106	102	94	97	91	94	88	90	86	84	84	84	84	84	84	84	84	84	84	84
2	99	90	83	78	96	88	77	85	75	82	73	79	72	69	69	69	69	69	69	69	69	69	69	69
3	90	79	71	64	87	77	64	74	62	72	61	69	60	58	58	58	58	58	58	58	58	58	58	58
4	82	70	61	54	80	68	53	66	53	63	52	61	51	49	49	49	49	49	49	49	49	49	49	49
5	75	62	53	46	73	61	46	59	45	57	45	55	44	42	42	42	42	42	42	42	42	42	42	42
6	69	55	46	40	67	55	40	53	39	51	39	49	39	36	36	36	36	36	36	36	36	36	36	36
7	64	50	41	35	62	49	35	48	34	46	34	45	34	32	32	32	32	32	32	32	32	32	32	32
8	59	46	37	31	58	45	31	43	31	42	30	41	30	28	28	28	28	28	28	28	28	28	28	28
9	55	42	33	28	54	41	27	40	27	39	27	38	27	25	25	25	25	25	25	25	25	25	25	25
10	52	38	30	25	50	38	25	37	25	36	24	35	24	23	23	23	23	23	23	23	23	23	23	23

Product	Transom 1x4	Description	Performance Summary		Light (lm)	Energy (W)	Efficacy (lm/W)	Color Accuracy		
Version	TR1-14C40	1x4 LED C Lumens CCT 4000 K	CCT Color Temperature	4000 K	4070	38.37	106.1	83.1	8.5	< 2
Report	Based on 11555052.04			3500 K	4045	38.37	105.4	83.1	8.5	< 2
				3000K	4021	38.37	104.8	82.2	5.2	< 2

100% Dn

### CANDLEPOWER DISTRIBUTION

Vertical Angle	Horizontal Angle				Zonal Lumens
	0°	22.5°	45°	67.5°	90°
0°	1088	1088	1088	1088	1088
5°	1087	1087	1098	1110	1116
15°	1054	1087	1181	1248	1274
25°	990	1088	1258	1355	1378
35°	897	1058	1251	1273	1267
45°	777	989	1105	1071	1059
55°	637	852	872	814	769
65°	477	646	594	389	356
75°	291	411	220	156	144
85°	76	78	38	30	30
90°	1	3	3	3	3
95°					
105°					
115°					
125°					
135°					
145°					
155°					
165°					
175°					
180°					

### LUMEN SUMMARY

Zone	Lumens	% Lamp	% Fixture
0-30°	1001	N.A.	25
0-60°	3236	N.A.	80
0-90°	4070	N.A.	100
90-180°	0	N.A.	0
Total Luminaire	4070	N.A.	100

### LUMINANCE DATA (CD/M<sup>2</sup>)

Vertical Angle	0°	45°	90°
45°	3289	4680	4485
55°	3323	4552	4013
65°	3378	4206	2525
75°	3362	2548	1670
85°	2604	1316	1034

### CO-EFFICIENTS OF UTILIZATION

Floor Ceiling Wall	80				70				20				50				30				10				0			
	70	50	30	10	70	50	30	10	50	10	50	10	50	10	50	10	50	10	50	10	50	10	50	10	50	10	50	10
0	119	119	119	119	116	116	116	111	111	106	106	102	102	100														
1	109	104	100	96	106	102	94	97	91	94	88	90	86	84														
2	99	90	83	78	96	88	77	85	75	82	73	79	72	69														
3	90	79	71	64	87	77	64	74	62	72	61	69	60	58														
4	82	70	61	54	80	68	53	66	53	63	52	61	51	49														
5	75	62	53	46	73	61	46	59	45	57	45	55	44	42														
6	69	55	46	40	67	55	40	53	39	51	39	49	39	36														
7	64	50	41	35	62	49	35	48	34	46	34	45	34	32														
8	59	46	37	31	58	45	31	43	31	42	30	41	30	28														
9	55	42	33	28	54	41	27	40	27	39	27	38	27	25														
10	52	38	30	25	50	38	25	37	25	36	24	35	24	23														

Integrating Sphere and Photometric results at 4000K by an independent accredited testing laboratory per IES LM-79-2008 and ANSI C78.377-2011. Results for 3000K & 3500K scaled based on integrating sphere results at 47W (D). Candlepower Distribution scaled per total lumens of Integrating Sphere results.

Product	Transom 1x4	Description	Performance Summary		Light (lm)	Energy (W)	Efficacy (lm/W)	Color Accuracy		
Version	TR1-14D40	1x4 LED D Lumens CCT 4000 K	CCT Color Temperature	4000 K	4732	46.34	102.1	83	8.2	< 2
Report	Based on 11555052.07			3500 K	4704	46.34	101.5	83	8.2	< 2
				3000K	4675	46.25	101.1	82.2	5.2	< 2

100% Dn

### CANDLEPOWER DISTRIBUTION

Vertical Angle	Horizontal Angle				Zonal Lumens
	0°	22.5°	45°	67.5°	90°
0°	1265	1265	1265	1265	1265
5°	1264	1264	1277	1290	1298
15°	1225	1264	1373	1451	1481
25°	1151	1265	1463	1575	1602
35°	1043	1230	1454	1480	1473
45°	903	1149	1285	1245	1232
55°	740	991	1014	946	894
65°	555	751	690	452	414
75°	338	477	256	181	168
85°	88	91	45	35	35
90°	2	3	4	4	4
95°					
105°					
115°					
125°					
135°					
145°					
155°					
165°					
175°					
180°					

### LUMEN SUMMARY

Zone	Lumens	% Lamp	% Fixture
0-30°	1164	N.A.	25
0-60°	3762	N.A.	80
0-90°	4732	N.A.	100
90-180°	0	N.A.	0
Total Luminaire	4732	N.A.	100

### LUMINANCE DATA (CD/M<sup>2</sup>)

Vertical Angle	0°	45°	90°
45°	3825	5441	5215
55°	3863	5293	4666
65°	3928	4890	2935
75°	3909	2962	1942
85°	3026	1532	1202

### CO-EFFICIENTS OF UTILIZATION

Floor Ceiling Wall	80				70				20				50				30				10				0			
	70	50	30	10	70	50	30	10	50	10	50	10	50	10	50	10	50	10	50	10	50	10	50	10	50	10	50	10
0	119	119	119	119	116	116	116	111	111	106	106	102	102	100														
1	109	104	100	96	106	102	94	97	91	94	88	90	86	84														
2	99	90	83	78	96	88	77	85	75	82	73	79	72	69														
3	90	79	71	64	87	77	64	74	62	72	61	69	60	58														
4	82	70	61	54	80	68	53	66	53	63	52	61	51	49														
5	75	62	53	46	73	61	46	59	45	57	45	55	44	42														
6	69	55	46	40	67	55	40	53	39	51	39	49	39	36														
7	64	50	41	35	62	49	35	48	34	46	34	45	34	32														
8	59	46	37	31	58	45	31	43	31	42	30	41	30	28														
9	55	42	33	28	54	41	27	40	27	39	27	38	27	25														
10	52	38	30	25	50	38	25	37	25	36	24	35	24	23														