



INBOX 1 X 4 NB2-14

Specification Data

Luminaire	INBOX 1 X 4 (NB2-14)	Type
Project		
Product		
Notes		



CROSS SECTION

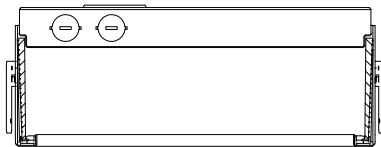

Performance Summary	Inbox 1 x 4			
	A	B	C	D
Light (lm)	2800	3400	4400	5300
Energy (W)	23	29	38	47
Efficacy (lm/W)	122	120	118	112
Color Rendering (CRI)	80+	80+	80+	80+
Color Accuracy (SDCM)	< 2	< 2	< 2	< 2
L70 Estimate (h)	200,000	200,000	200,000	200,000
Lumen Maintenance per TM21 (@ 60,000 h)	L90	L90	L90	L90

DLC qualified for each lumen output (A, B, C, D) in 3000K, 3500K & 4000K. Summary values are nominal and based on 4000K CCT.

DIMENSIONS inches (mm)

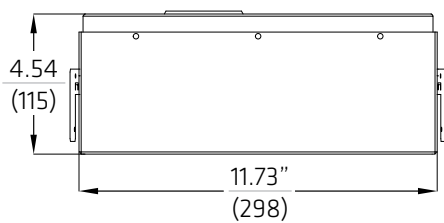

FRONT VIEW

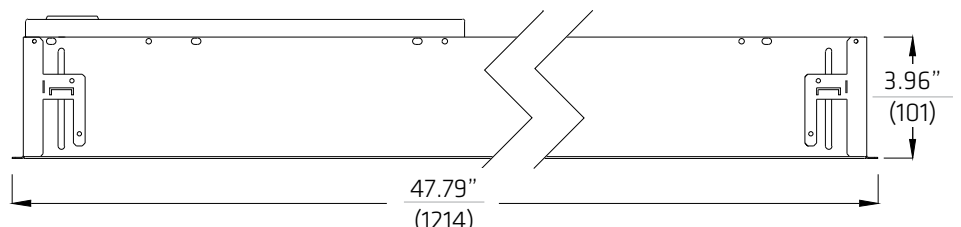

SIDE VIEW

SPECIFICATION

NB2		14						OPTIONS	
1	2	3	4	5	6				
1. FAMILY	2. SIZE	3. ENERGY ¹	4. CCT	5. DRIVER	6. VOLTAGE	OPTIONS			
NB2 Inbox	12 1 x 2 (2-sided optics)	A 23 W	30 3000 K	E1 eldoLED ECO 0-10V Dim 1%	M 120 - 277 V	B Battery Pack ⁴ C Chicago Plenum F 6' Flex Whip K Drywall Flange Kit			
	14 1 x 4 (2-sided optics)	B 29 W	35 3500 K	E2 eldoLED SOLO 0-10V Dim 0.1%					
	22 2 x 2 (2-sided optics)	C 38 W	40 4000 K	E3 eldoLED ECO DALI 1%	3 347 V ³				
	24 2 x 4 (2-sided optics)	D 47 W ²		E4 eldoLED SOLO DALI Dim 0.1%					
NB1 Inbox	22 2 x 2 (4-sided optics)	¹ Add 4W to above for 347V with E1-4/L1		F1 Factory Non- Dim	³ 347 V Driver for F1/F2 347 V Transformer & Driver E1-4/L1				
		² 1 x 4 2 x 4 2 x 2 (4 sided) only		F2 Factory 0-10V Dim 3%	⁴ Available for 120-277V				
				L1 Lutron Hi-Lume 1%-H EcoSystem					

CEILING INTEGRATION GRID

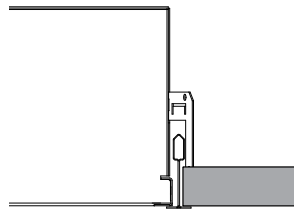

FLAT GRID

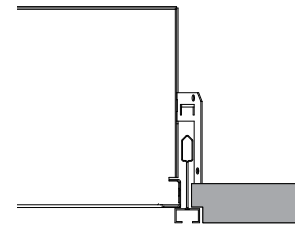

SLOT GRID

CEILING INTEGRATION DRYWALL

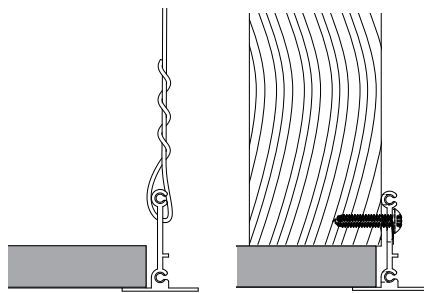

DRYWALL FLANGE KIT

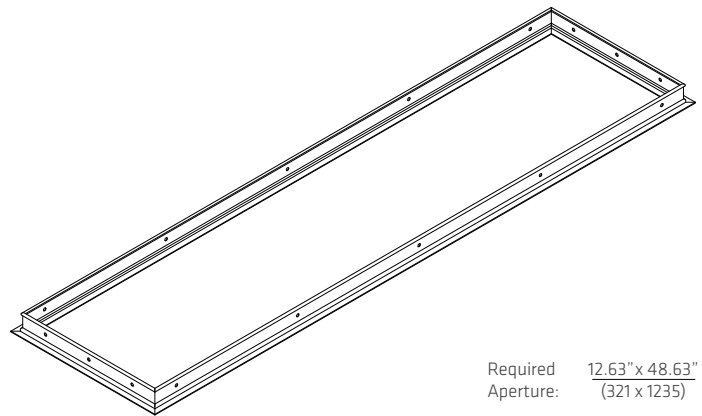

Required Aperture: 12.63" x 48.63"
(321 x 1235)

CONSTRUCTION

- Die formed 22 ga. steel housing
- Quick wire access plate and integral seismic restraint tabs/tie-offs
- Option for (K) drywall flange kit
- High reflectance diffuse white textured powdercoat

OPTICAL

- Anidolic optical structures with linear light extraction elements
- Precision extruded high transmittance clear acrylic lenses
- Long life LED system designed for typical TM21 lumen maintenance \geq L90 @ 60,000 h
- Available in CCTs 3000 K, 3500 K or 4000 K with CRI \geq 80 and R9 \geq 0, all with color accurate binning \leq 2 SDCM

ELECTRICAL

- Integral high efficiency drivers 120 - 277 V or 347 V; 50 - 60 Hz
- Power Factor $>$ 0.90
- Total Harmonic Distortion $<$ 20%
- F2:0 - 10 V Dim Range: 3 - 100%
- Optional Battery Pack
- Optional Lutron: Hi-lume H-Series EcoSystem LED drivers for 100 - 1% (PWM) dim range
- Optional flex whip: 6' prewired
- Surge Protection: Meets ANSI C82.11 spec and ANSI/IEEE C62.41
- Inrush Current: Meets NEMA 410

WEIGHT

- Maximum 18 lb (8.0 kg)
- Maximum 21 lb (10 kg) with battery pack

WARRANTY

- 5 year limited warranty on all components and workmanship

ENVIRONMENTAL

- Designed for use in damp or dry indoor environments with room side operating temperatures of 0 - 30° C (32 - 86° F)

INDEPENDENT TESTING

- IESNA LM79
- IESNA LM80 (LED@ 10,000 h)

APPROVALS

- UL Listed (USA + Canada)
- CCEA Chicago Plenum
- DesignLights Consortium®
- Lighting Facts®
- IC Rated

Product	Inbox 1x4	Description	Performance Summary		Light (lm)	Energy (W)	Efficacy (lm/W)	Color Accuracy (CRI) (R9) (SDCM)		
Version	NB2-14A40	1x4 LED A Lumens CCT 4000 K	CCT Color Temperature	4000 K	2779	23	121.8	82	2.4	< 2
Report	FLUXWERX			3500 K	2645	23	115	82	3	< 2
				3000K	2511	22.8	110	82	5.7	< 2

100% Dn

Vertical Angle	Horizontal Angle				Zonal Lumens
	0°	22.5°	45°	67.5°	
0°	524	524	524	524	524
5°	522	523	524	527	530
15°	508	525	660	747	775
25°	478	602	801	892	912
35°	433	642	829	872	872
45°	375	631	764	765	760
55°	304	563	631	611	580
65°	224	452	474	369	353
75°	137	319	249	182	157
85°	50	111	55	46	44
90°	1	3	2	2	2
95°					
105°					
115°					
125°					
135°					
145°					
155°					
165°					
175°					
180°					

Zone	Lumens	% Lamp	% Fixture
0-30°	581	N.A.	21
0-60°	2075	N.A.	75
0-90°	2778	N.A.	100
90-180°	0	N.A.	0
Total Luminaire	2779	N.A.	100

Vertical Angle	0°	45°	90°
45°	1704	3474	3455
55°	1706	3538	3249
65°	1707	3607	2684
75°	1705	3090	1951
85°	1830	2029	1638

Floor Ceiling Wall	80				70				20			
	70	50	30	10	70	50	30	10	50	10	50	10
0	119	119	119	119	116	116	116	111	111	106	106	102
1	108	102	98	94	105	100	92	96	89	92	86	88
2	97	88	81	75	94	86	74	83	72	79	70	76
3	88	76	68	61	85	75	60	72	59	69	58	66
4	80	67	58	50	77	66	50	63	49	61	49	58
5	73	59	50	43	71	58	42	56	42	54	41	52
6	67	53	43	37	65	52	36	50	36	48	36	47
7	62	47	38	32	60	47	32	45	31	44	31	42
8	57	43	34	28	56	42	28	41	28	40	27	38
9	53	39	31	25	52	39	25	37	24	36	24	35
10	50	36	28	22	48	35	22	34	22	33	22	32

Integrating Sphere and Photometric results at 4000K , 47W (D) by an independent accredited testing laboratory per IES LM-79-2008 and ANSI C78.377-2011. Results for 3000K, 3500K scaled based on integrating sphere results at 47W (D) and 2x2-4sided integrated sphere results for Lumen outputs A, B, C. Candlepower Distribution scaled per total lumens of Integrating Sphere results.

Product	Inbox 1x4	Description	Performance Summary		Light (lm)	Energy (W)	Efficacy (lm/W)	Color Accuracy (CRI) (R9) (SDCM)		
Version	NB2-14B40	1x4 LED B Lumens CCT 4000 K	CCT Color Temperature	4000 K	3422	28.4	120.5	82	2.4	< 2
Report	FLUXWERX			3500 K	3257	28.3	115	82	3	< 2
				3000K	3092	28.4	109	82	4.7	< 2

100% Dn

Vertical Angle	Horizontal Angle				Zonal Lumens
	0°	22.5°	45°	67.5°	
0°	646	646	646	646	646
5°	642	645	646	649	652
15°	625	646	812	920	954
25°	589	742	987	1099	1124
35°	533	790	1020	1073	1074
45°	461	778	941	943	936
55°	375	693	778	752	714
65°	276	557	584	454	435
75°	169	393	306	224	194
85°	61	137	68	57	55
90°	1	4	3	3	2
95°					
105°					
115°					
125°					
135°					
145°					
155°					
165°					
175°					
180°					

Zone	Lumens	% Lamp	% Fixture
0-30°	715	N.A.	21
0-60°	2555	N.A.	75
0-90°	3422	N.A.	100
90-180°	0	N.A.	0
Total Luminaire	3422	N.A.	100

Vertical Angle	0°	45°	90°
45°	2098	4279	4255
55°	2101	4358	4000
65°	2102	4442	3305
75°	2100	3806	2403
85°	2250	2497	2018

Floor Ceiling Wall	80				70				20			
	70	50	30	10	70	50	30	10	50	10	50	10
0	119	119	119	119	116	116	116	111	111	106	106	102
1	108	102	98	94	105	100	92	96	89	92	86	88
2	97	88	81	75	94	86	74	83	72	79	70	76
3	88	76	68	61	85	75	60	72	59	69	58	66
4	80	67	58	50	77	66	50	63	49	61	49	58
5	73	59	50	43	71	58	42	56	42	54	41	52
6	67	53	43	37	65	52	36	50	36	48	36	47
7	62	47	38	32	60	47	32	45	31	44	31	42
8	57	43	34	28	56	42	28	41	28	40	27	38
9	53	39	31	25	52	39	25	37	24	36	24	35
10	50	36	28	22	48	35	22	34	22	33	22	32

Product	Inbox 1x4	Description	Performance Summary			Light (lm)	Energy (W)	Efficacy (lm/W)	Color Accuracy (CRI) (R9) (SDCM)		
Version	NB2-14C40	1x4 LED C Lumens CCT 4000 K	CCT Color Temperature	4000 K	4403	37.4	117.6	82	2.4	< 2	
Report	FLUXWERX			3500 K	4191	37.4	112	82	3	< 2	
				3000K	3979	37.5	106	82	4.7	< 2	

100% Dn

CANDLEPOWER DISTRIBUTION

Vertical Angle	Horizontal Angle				Zonal Lumens
	0°	22.5°	45°	67.5°	
0°	831	831	831	831	831
5°	827	829	831	835	839
15°	804	832	1045	1184	1227
25°	758	955	1270	1414	1446
35°	686	1017	1313	1381	1382
45°	594	1000	1211	1213	1204
55°	482	892	1000	968	918
65°	356	717	752	584	559
75°	218	505	394	288	249
85°	79	176	87	73	70
90°	2	5	3	3	3
95°					
105°					
115°					
125°					
135°					
145°					
155°					
165°					
175°					
180°					

LUMEN SUMMARY

Zone	Lumens	% Lamp	% Fixture
0-30°	920	N.A.	21
0-60°	3287	N.A.	75
0-90°	4403	N.A.	100
90-180°	0	N.A.	0
Total Luminaire	4403	N.A.	100

LUMINANCE DATA (CD/M²)

Vertical Angle	0°		45°		90°	
	0°	45°	0°	45°	0°	45°
45°	2699	5506	5474			
55°	2703	5607	5147			
65°	2704	5717	4253			
75°	2703	4896	3092			
85°	2896	3213	2593			

CO-EFFICIENTS OF UTILIZATION

Floor Ceiling	80				70				20				30				10				0					
	70	50	30	10	70	50	30	10	50	50	10	50	10	50	10	50	10	50	10	50	10	50	10	50	10	50
0	119	119	119	119	116	116	116	111	111	111	111	106	106	102	102	100										
1	108	102	98	94	105	100	92	96	89	92	86	88	84	82												
2	97	88	81	75	94	86	74	83	72	79	70	76	69	66												
3	88	76	68	61	85	75	60	72	59	69	58	66	57	55												
4	80	67	58	50	77	66	50	63	49	61	49	58	48	46												
5	73	59	50	43	71	58	42	56	42	54	41	52	41	39												
6	67	53	43	37	65	52	36	50	36	48	36	47	35	33												
7	62	47	38	32	60	47	32	45	31	44	31	42	31	29												
8	57	43	34	28	56	42	28	41	28	40	27	38	27	25												
9	53	39	31	25	52	39	25	37	24	36	24	35	24	22												
10	50	36	28	22	48	35	22	34	22	33	22	32	22	20												

Integrating Sphere and Photometric results at 4000K . 47W (D) by an independent accredited testing laboratory per IES LM-79-2008 and ANSI C78.377-2011. Results for 3000K, 3500K scaled based on integrating sphere results at 47W (D) and 2x2-4sided integrated sphere results for Lumen outputs A, B, C. Candlepower Distribution scaled per total lumens of Integrating Sphere results.

Product	Inbox 1x4	Description	Performance Summary			Light (lm)	Energy (W)	Efficacy (lm/W)	Color Accuracy (CRI) (R9) (SDCM)		
Version	NB2-14D40	1x4 LED D Lumens CCT 4000 K	CCT Color Temperature	4000 K	5265	47	112	82.3	2.4	< 2	
Report	11660485.13			3500 K	5012	47	107	82	3	< 2	
				3000K	4758	47.2	101	82	4.7	< 2	

100% Dn

CANDLEPOWER DISTRIBUTION

Vertical Angle	Horizontal Angle				Zonal Lumens
	0°	22.5°	45°	67.5°	
0°	993	993	993	993	993
5°	988	992	993	999	1004
15°	962	995	1250	1416	1468
25°	906	1142	1518	1691	1729
35°	820	1216	1570	1651	1653
45°	710	1196	1448	1450	1440
55°	577	1066	1196	1157	1098
65°	425	857	899	699	669
75°	260	604	471	344	298
85°	94	210	104	87	84
90°	2	6	4	4	4
95°					
105°					
115°					
125°					
135°					
145°					
155°					
165°					
175°					
180°					

LUMEN SUMMARY

Zone	Lumens	% Lamp	% Fixture
0-30°	1100	N.A.	21
0-60°	3931	N.A.	75
0-90°	5265	N.A.	100
90-180°	0	N.A.	0
Total Luminaire	5265	N.A.	100

LUMINANCE DATA (CD/M²)

Vertical Angle	0°		45°		90°	
	0°	45°	0°	45°	0°	45°
45°	3227	6584	6546			
55°	3233	6705	6155			
65°	3234	6835	5085			
75°	3232	5855	3698			
85°	3464	3840	3102			

CO-EFFICIENTS OF UTILIZATION

Floor Ceiling	80				70				20				30				10				0					
	70	50	30	10	70	50	30	10	50	50	10	50	10	50	10	50	10	50	10	50	10	50	10	50	10	
0	119	119	119	119	116	116	116	111	111	111	111	106	106	102	102	100										
1	108	102	98	94	105	100	92	96	89	92	86	88	84	82												
2	97	88	81	75	94	86	74	83	72	79	70	76	69	66												
3	88	76	68	61	85	75	60	72	59	69	58	66	57	55												
4	80	67	58	50	77	66	50	63	49	61	49	58	48	46												
5	73	59	50	43	71	58	42	56	42	54	41	52	41	39												
6	67	53	43	37	65	52	36	50	36	48	36	47	35	33												
7	62	47	38	32	60	47	32	45	31	44	31	42	31	29												
8	57	43	34	28	56	42	28	41	28	40	27	38	27	25												
9	53	39	31	25	52	39	25	37	24	36	24	35	24	22												
10	50	36	28	22	48	35	22	34	22	33	22	32	22	20												

